

Agilent 7890 Series Gas Chromatograph

Advanced Operation Manual

Notices

© Agilent Technologies, Inc. 2007-2013

No part of this manual may be reproduced in any form or by any means (including electronic storage and retrieval or translation into a foreign language) without prior agreement and written consent from Agilent Technologies, Inc. as governed by United States and international copyright laws.

Manual Part Number

G3430-90015

Edition

Thirteenth edition, December 2013
Twelfth edition, January 2013
Eleventh edition, July 2012
Tenth edition, March 2012
Ninth edition, June 2011
Eighth edition, February 2011
Seventh edition, November 2010
Sixth edition, June 2010
Fifth edition, September 2009
Fourth edition, April 2009
Third edition, September 2008
Second edition, January 2008
First edition, April 2007

Printed in USA

Agilent Technologies, Inc.
2850 Centerville Road
Wilmington, DE 19808-1610 USA

安捷伦科技（上海）有限公司
上海市浦东新区外高桥保税区
英伦路 412 号
联系电话：（800）820 3278

Safety Notices

CAUTION

A **CAUTION** notice denotes a hazard. It calls attention to an operating procedure, practice, or the like that, if not correctly performed or adhered to, could result in damage to the product or loss of important data. Do not proceed beyond a **CAUTION** notice until the indicated conditions are fully understood and met.

WARNING

A **WARNING** notice denotes a hazard. It calls attention to an operating procedure, practice, or the like that, if not correctly performed or adhered to, could result in personal injury or death. Do not proceed beyond a **WARNING** notice until the indicated conditions are fully understood and met.

Firmware Version

This manual is written for 7890 Series GCs using firmware version B.02.02.

Contents

1 Programming

Run Time Programming	12
Using run time events	12
Programming run time events	13
The run table	13
Adding events to the run table	13
Editing events in the run table	14
Deleting run time events	14
Clock Time Programming	15
Using clock time events	15
Programming clock time events	15
Adding events to the clock table	16
Editing clock time events	16
Deleting clock time events	16
User-Key Programming	17
To program a User Key	17
To play back (execute) the stored keystrokes	17
To erase the stored keystrokes	17
Post Run Programming	18
To enable a post run program	18
To disable a post run program	18

2 Flow and Pressure Modules

About Flow and Pressure Control	20
Maximum operating pressure	20
PIDs	21
Inlet Modules	22
Detector Modules	23
Pressure Control Modules	24
Auxiliary Pressure Controllers	27
Restrictors	28
Examples	30
1. Using an Aux EPC channel to supply purge gas to a splitter	30
2. Using the PCM channels	31

3 Inlets

Using Hydrogen	35
Inlet Overview	36
Carrier Gas Flow Rates	37
About Gas Saver	38
To use gas saver	39
Pre Run and Prep Run	40
The [Prep Run] key	40
Auto Prep Run	41
About the Split/Splitless Inlet	42
Septum tightening (S/SL)	42
Standard and high-pressure versions of the S/SL inlet	42
Split/Splitless inlet split mode overview	43
Split/Splitless inlet splitless mode overview	44
The S/SL inlet pulsed split and splitless modes	45
Split/Splitless inlet split mode minimum operating pressures	46
Selecting the correct S/SL inlet liner	47
Vapor Volume Calculator	49
Setting parameters for the S/SL split mode	49
Selecting parameters for the S/SL splitless mode	50
Setting parameters for the S/SL splitless mode	51
Setting parameters for the S/SL pulsed modes	52
About the Multimode Inlet	53
Septum tightening (MMI)	53
Heating the MMI	54
Cooling the MMI	54
MMI split mode minimum operating pressures	55
Selecting the correct MMI liner	56
Vapor Volume Calculator	58
MMI split and pulsed split modes	58
MMI splitless and pulsed splitless modes	62
MMI solvent vent mode	68
MMI Direct Mode	76
To develop a MMI method that uses large volume injection	77
Multiple injections with the MMI	80
About the Packed Column Inlet	86
Setting parameters	88
About the Cool On-Column Inlet	90
Setup modes of the COC inlet	91
Retention gaps	91

COC inlet temperature control	91
Setting COC inlet flows/pressures	92
Setting COC inlet parameters	93
About the PTV Inlet	94
PTV sampling heads	94
Heating the PTV inlet	95
Cooling the PTV inlet	96
PTV inlet split and pulsed split modes	96
PTV inlet splitless and pulsed splitless modes	100
PTV inlet solvent vent mode	107
To develop a PTV method that uses large volume injection	115
Multiple injections with the PTV inlet	118
About the Volatiles Interface	124
VI operating modes	125
About the VI split mode	126
About the VI splitless mode	130
About the VI direct mode	135
Preparing the Interface for Direct Sample Introduction	138
VI direct mode setpoint dependencies	140
VI direct mode initial values	140
Setting parameters for the VI direct mode	141

4 Columns and Oven

About the Oven	144
Oven safety	144
Configuring the Oven	145
Cryogenic Operation	146
Cryogenic setpoints	146
About Oven Temperature Programming	148
Programming setpoints	148
Oven ramp rates	149
Setting the oven parameters for constant temperature	150
Setting the oven parameters for ramped temperature	150
About the Oven Insert	152
About Columns	153
Selecting the correct packed glass column type	153
About the column modes	153
Select a column mode	154
Setting the column parameters for constant flow or constant pressure	155
Enter a flow or pressure program (optional)	155

Programming column pressure or flow	156
Backflushing a Column	157
Backflushing when connected to an MS instrument	158
Backflushing using a capillary flow technology device	158
Advantages of the optional Backflush Wizard	159
Procedures for manually creating a backflush method	160
Nickel Catalyst Tube	164
About the nickel catalyst tube	164
Nickel catalyst gas flows	164
Setting temperatures for the nickel catalyst tube	165
Hydrogen Sensor	166
Instrument logs	166
Calibration	166
Status information	166
Operation with an Agilent data system	167

5 Detectors

About Makeup Gas	170
About the FID	171
How FID units are displayed in Agilent data systems and on the GC	172
To light the FID flame	173
To extinguish the FID flame	173
FID automatic reignition (Lit offset)	173
Recommended starting conditions for new FID methods	174
Setting parameters for FID	175
About the TCD	176
TCD pneumatics	178
TCD carrier, reference, and makeup gas	178
TCD gas pressures	179
Selecting reference and makeup flows for the TCD	180
Chemically active compounds reduce TCD filament life	180
Changing the TCD polarity during a run	181
Detecting hydrogen with the TCD using helium carrier gas	181
Setting parameters for the TCD	182
About the uECD	184
uECD safety and regulatory information	184
uECD warnings	185
Safety precautions when handling uECDs	186
uECD gas flows	187
uECD linearity	187
uECD detector gas	187

uECD temperature	187
uECD analog output	188
Recommended starting conditions for new uECD methods	188
uECD makeup gas notes	188
uECD temperature programming	189
Setting parameters for the uECD	189
About the NPD	190
New NPD features and changes	190
NPD software requirements	190
NPD flows and general information	190
NPD flow, temperature, and bead recommendations	191
NPD required gas purity	193
Setting parameters for the NPD	194
Selecting an NPD bead type	195
Changing from a ceramic bead to a Blos bead	196
Selecting an NPD jet	196
To configure the NPD	197
Automatically adjusting NPD bead voltage	198
Setting NPD adjust offset on the clock table	199
Aborting NPD adjust offset	199
Extending the NPD bead life	199
Setting the initial bead voltage for new beads	200
Setting NPD bead voltage manually (optional)	201
About the FPD⁺	202
FPD ⁺ linearity	203
FPD ⁺ Lit Offset	203
FPD ⁺ photomultiplier protection	204
FPD ⁺ optical filters	204
Inlet liners for use with the FPD ⁺	204
FPD ⁺ temperature considerations	204
FPD ⁺ gas purity	205
FPD ⁺ gas flows	205
Lighting the FPD ⁺ flame	206
Setting parameters for the FPD ⁺	207
About the FPD	209
FPD linearity	210
FPD Lit Offset	210
Starting Up and Shutting Down the FPD	210
FPD photomultiplier protection	210
FPD optical filters	210
Inlet liners for use with the FPD	211
FPD temperature considerations	211

FPD gas purity	211
FPD gas flows	211
Lighting the FPD flame	212
Setting parameters for the FPD	213

6 Valves

About Valves	216
The Valve Box	217
Heating the valves	217
Valve temperature programming	218
Configuring an Aux thermal zone	218
Valve Control	219
The valve drivers	219
The internal valve drivers	219
The external valve drivers	220
Valve Types	221
Configuring a Valve	222
Controlling a Valve	223
From the keyboard	223
From the run or clock time tables	223
Simple valve: column selection	223
Gas sampling valve	224
Multiposition stream selection valve with sampling valve	225

7 GC Output Signals

About Signals	228
Signal Types	229
Value	229
Analog Signals	231
Analog zero	231
Analog range	231
Analog data rates	232
Selecting fast peaks (analog output)	233
Digital Signals	234
Digital zero	234
Signal Freeze and Resume	234
Data rates with Agilent data systems	235
Zero Init Data Files	237

Column Compensation	238
Creating a column compensation profile	239
Making a run using analog output column compensation	239
Making a run using digital output column compensation	239
Plotting a stored column compensation profile	240
Test Plot	241

8 Auxiliary Devices

Auxiliary Devices	244
About Auxiliary Pressure Control	244
About Aux Thermal Zone Control	245
About Cryo Trap Control	245
About Auxiliary Device Contacts	246
About the 24V Auxiliary Device Power Supply	246
About Auxiliary Columns	246
About Auxiliary Detectors	247

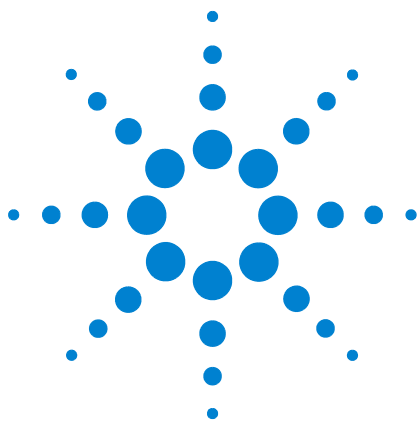

1 Programming

Run Time Programming	12
Using run time events	12
Programming run time events	13
The run table	13
Adding events to the run table	13
Editing events in the run table	14
Deleting run time events	14
Clock Time Programming	15
Using clock time events	15
Programming clock time events	15
Adding events to the clock table	16
Editing clock time events	16
Deleting clock time events	16
Post Run Programming	18
User-Key Programming	17
To play back (execute) the stored keystrokes	17
To erase the stored keystrokes	17
To program a User Key	17

Run Time Programming

Run time programming during a method allows certain setpoints to change automatically during a run as a function of the chromatographic run time. Thus an event that is programmed to occur at 2 minutes will occur 2 minutes after every injection.

Its uses include:

- Controlling column switching or other valves
- Changing analog signal definition, zero, or range
- Controlling an auxiliary pressure channel
- Changing polarity of a thermal conductivity detector (TCD)
- Turning the hydrogen flow to a nitrogen-phosphorus detector (NPD) on or off
- Switching digital signal output (requires an Agilent data system)
- Pausing (“freezing”) and resuming digital signal output (requires an Agilent data system)

The changes are entered into a run table that specifies the setpoint to be changed, the time for the change, and the new value. At the end of the chromatographic run, most setpoints changed by a run time table are returned to their original values.

Valves can be run time programmed but are *not* restored to their starting position at the end of the run. You must program the reset operation in the run table if this action is desired. See [“From the run or clock time tables”](#) on page 223.

Using run time events

The **[Run Table]** key is used to program the following timed events.

- Valves (1-8)
- Multiposition valve
- Signal type (see [“Signal Types”](#) on page 229)
- Analog signal definition, zero, and range
- Auxiliary pressures (1 through 9)
- TCD negative polarity (on/off)

- Detector gas flow (on/off), including NPD H₂ fuel gas
- Inlet septum purge flow

Programming run time events

- 1 Press **[Run Table]**.
- 2 Press **[Mode/Type]** to see the available run time events.
- 3 Scroll to the event to be programmed. Press **[Enter]**.
- 4 Enter values for the **Time:** and the other parameter. Press **[Enter]** after each entry.
- 5 Press **[Mode/Type]** to add another event. Press **[Status]** to terminate entries.

The run table

The programmed events are arranged in order of execution time in the Run Table. This is a brief example:

RUN TABLE (1 of 3)	Event 1 rotates a valve.
Time: 0.10	
Valve #2 On	
RUN TABLE (2 of 3)	Event 2 adjusts the signal range.
Time: 3	
Analog signal 2 range 2	
RUN TABLE (3 of 3)	Event 3 resets Valve #2 to its original position in preparation for another run. Valves do not reset automatically.
Time: 4.20	
Valve #2 Off	

Adding events to the run table

- 1 To add new events to the run table, press **[Mode/Type]** while on the **Time:** line of any entry.
- 2 Select the event type.
- 3 Set appropriate **Time:** and other parameters. Some require numbers; others require **[On/Yes]** or **[Off/No]**.
- 4 Repeat until all entries are added. Events are automatically placed in order by execution time.

Editing events in the run table

- 1 Press **[Run Table]**.
- 2 Move the cursor to the event you want to change.
- 3 To edit the time for an event, move the cursor to the line labeled **Time:**. Type the desired time and press **[Enter]**.
- 4 To edit a setpoint value, scroll to the setpoint line. Press **[On/Yes]** or **[Off/No]** or enter a numeric value for the setpoint. Press **[Enter]**.

Deleting run time events

- 1 Press **[Run Table]**.
- 2 From within this table press **[Delete]** to delete events from the run time table. You will be asked to confirm the deletion.
- 3 Press **[On/Yes]** to delete the current timed event; press **[Off/No]** to cancel this operation.
- 4 To delete the entire table, press **[Delete][Run Table]**.

Clock Time Programming

Clock time programming allows certain setpoints to change automatically at a specified time during a 24-hour day. Thus, an event programmed to occur at 14:35 hours will occur at 2:35 in the afternoon. A running analysis or sequence has precedence over any clock table events occurring during this time. Such events are not executed.

Possible clock time events include:

- Valve control
- Method and sequence loading
- Starting sequences
- Initiating blank and prep runs
- Column compensation changes
- Adjustments of the detector offset

Using clock time events

The Clock Table function allows you to program events to occur during a day based on the 24-hour clock. Clock table events that would occur during a run or sequence are ignored.

For example, the clock table could be used to make a blank run before you even get to work in the morning.

Programming clock time events

- 1 Press [**Clock Table**].
- 2 Press [**Mode/Type**] to see the available clock time events.
- 3 Scroll to the parameter to be programmed.
- 4 Edit **Time:** and the setpoints for this event.
- 5 Press [**Mode/Type**] to add another event. Press [**Status**] to terminate entries.

When the clock event is executed, a confirming message appears.

Adding events to the clock table

- 1 Press [**Clock Table**].
- 2 Press [**Mode/Type**]. When entries are added, they are automatically ordered chronologically.
- 3 Select the event type.
- 4 Set appropriate parameters.
- 5 Repeat this process until all entries are added.

Editing clock time events

- 1 Press [**Clock Table**] to view all events programmed.
- 2 Scroll to the event you want to change.
- 3 To edit the time for an event, move the cursor to the line labelled **Time:** and type the desired time.
- 4 To edit a setpoint value, scroll to the setpoint item. Press [**On/Yes**] or [**Off/No**], or enter a numerical value for the setpoint.

Deleting clock time events

- 1 Press [**Clock Table**].
- 2 Use [**Delete**] to remove events from the clock time table. You will be asked to confirm the deletion.
- 3 Press [**On/Yes**] to delete the current timed event; press [**Off/No**] to cancel this operation.

To delete the entire table, press [**Delete**][**Clock Table**].

User-Key Programming

The two User Keys create macros (sets of frequently used keystrokes) and assign them to single keys. A macro is executed when the User Key is pressed.

The stored keystrokes may be any keys except **[Start]**, **[Prog]**, **[User Key 1]**, or **[User Key 2]**.

This discussion assumes that you wish to program **[User Key 1]**. The process is the same for **[User Key 2]**.

To program a User Key

- 1 Press **[Prog]**. Press **[User Key 1]**.
- 2 Press up to 31 keys, then press **[User Key 1]**. The keystrokes are stored.

To play back (execute) the stored keystrokes

Press **[User Key 1]**.

To erase the stored keystrokes

Press **[Prog][User Key 1][User Key 1]**. This creates an “empty” macro.

Post Run Programming

This function can be used with both isothermal and programmed methods. Post run is a period that begins at the end of the normal run. The parameters include:

- **Time**—How long is the post run period?
- **Oven Temperature**—What is the oven temperature during the post run period?
- **Column *n* pres**—For a column controlled in a pressure mode, enter the pressure for this column during the post run period.
- **Column *n* flow**—For a column controlled in a flow mode, enter the flow rate for this column during the post run period.
- **Enable Front inlet temp**—For the Multimode inlet, set the post run inlet temperature. You can also press [**On/Yes**] and [**Off/No**] to turn this parameter on or off.
- **Enable Front inlet total flow**—For the Multimode inlet, set the post run inlet total flow rate. You can also press [**On/Yes**] and [**Off/No**] to turn this parameter on or off.

Post run may be used to clean out a column in preparation for the next run, backflush a column to eliminate high-boilers, and other functions.

When the Post run **Time** elapses, the GC returns to the initial state defined in the current method. If it uses cryogenic cooling and you do not start another run quickly, you could waste considerable coolant while waiting for the next run. A solution is to use a sequence that loads a less wasteful method.

To enable a post run program

- 1 Press [**Post Run**].
- 2 Type a non-zero time for the post run duration and press [**Enter**]. The post run parameters available for the current GC configuration appear.
- 3 Scroll to each desired parameter, type the value for the post run period, and press [**Enter**].

To disable a post run program

- 1 Press [**Post Run**].
- 2 Type a 0 as the post run time and press [**Enter**].



2 Flow and Pressure Modules

About Flow and Pressure Control	20
Maximum operating pressure	20
PIDs	21
Inlet Modules	22
Detector Modules	23
Pressure Control Modules	24
Auxiliary Pressure Controllers	27
Restrictors	28
1. Using an Aux EPC channel to supply purge gas to a splitter	30
2. Using the PCM channels	31

About Flow and Pressure Control

The GC uses four types of electronic flow or pressure controllers; inlet modules, detector modules, pressure control modules (PCMs), and auxiliary pressure controllers (Aux EPCs).

All of these modules mount in the slots at the top rear of the GC. The slots are identified by numbers, as shown here.

Slot 5	Slot 3	Slot 1	Split vent traps and valves
Slot 6	Slot 4	Slot 2	

Back of GC

When a module is installed in a slot, it must be connected to the communications buss that runs underneath it. Each branch of the buss has an identifying label near the connector. The proper branch must be connected to the module for the firmware to recognize it.

Branch/slot assignments are:

EPC5	EPC3	EPC1	Split vent traps and valves
EPC6	EPC4	EPC2	

Back of GC

If a detector is mounted in the left side carrier (as seen from the front side of the oven), it is controlled by **EPC6**. An extension cable connects to **EPC6**, runs across the top of the oven just in front of the top row of slots, and passes through an opening into the detector carrier.

Maximum operating pressure

The pneumatics modules of the GC will stand over 250 psi pressure, but may not function reliably. We recommend a maximum continuous operating pressure of 170 psi to avoid excessive wear and leaks.

PIDs

The behavior of a pressure control module is governed by a set of three constants, called **P** (proportional), **I** (integral), and **D** (differential).

Certain gases or special applications (such as headspace vial pressurization, flow splitter, and backflush applications) require different PIDs than those provided at the factory.

If you need to update or change the pneumatic PID values for an application, use the utility program on the *GC and GC/MS User Manuals & Tools DVD* provided with the GC.

The table summarizes custom PID values required for selected applications. Note that if you are updating an AUX EPC module, you will need to change the frit for the channel used. See also “[Restrictors](#).”

Table 1 PIDs and frits

Application	Module	AUX frit	Select Available PID Values
QuickSwap	AUX EPC	1 ring (or brown dot)	Quickswap
Purged splitter and Deans Switch when using backflush	AUX EPC	No color or rings	Quickswap
Purged splitter and Deans Switch	AUX EPC	1 ring (or brown dot)	Standard
Headspace vial pressurization	AUX EPC	No color or rings	AUX_EPC_Headspace
Headspace sampling loop	PCM in backpressure control		PCM_Headspace

Inlet Modules

These modules are used with specific inlets. They provide a controlled flow or pressure of carrier gas to the inlet and control the septum flow rate.

Module locations depend on the type of module and the length of the tubing connecting it to the inlet.

If you have a **Front inlet**, its flow module must go in Slot 1.

If you have a **Back inlet**, its flow module must go in Slot 2.

Detector Modules

These are specific to the detector with which they are supplied, and differ according to the needs of that detector. For example, the FID module must supply controlled amounts of air, hydrogen, and makeup gas. The TCD module supplies the reference and makeup gases, but includes the reference switching valve that is essential to detector operation.

Module locations depend on the type of module and the length of the tubing connecting it to the detector.

If you have a **Front detector**, its flow module must go in Slot 3.

If you have a **Back detector**, its flow module must go in Slot 4.

If you have a detector mounted on the left side of the GC, its flow module mounts in a special bracket near the detector.

Pressure Control Modules

The PCM is a general purpose module with two independent control channels, designated 1 and 2. The general name of a PCM module is **PCM #**, where the # (actually, a letter) identifies the PCM (there can be up to 3 installed).

The two channels are not identical. Channel 1 is a simple forward-pressure regulated channel that maintains constant flow through a fixed restrictor.

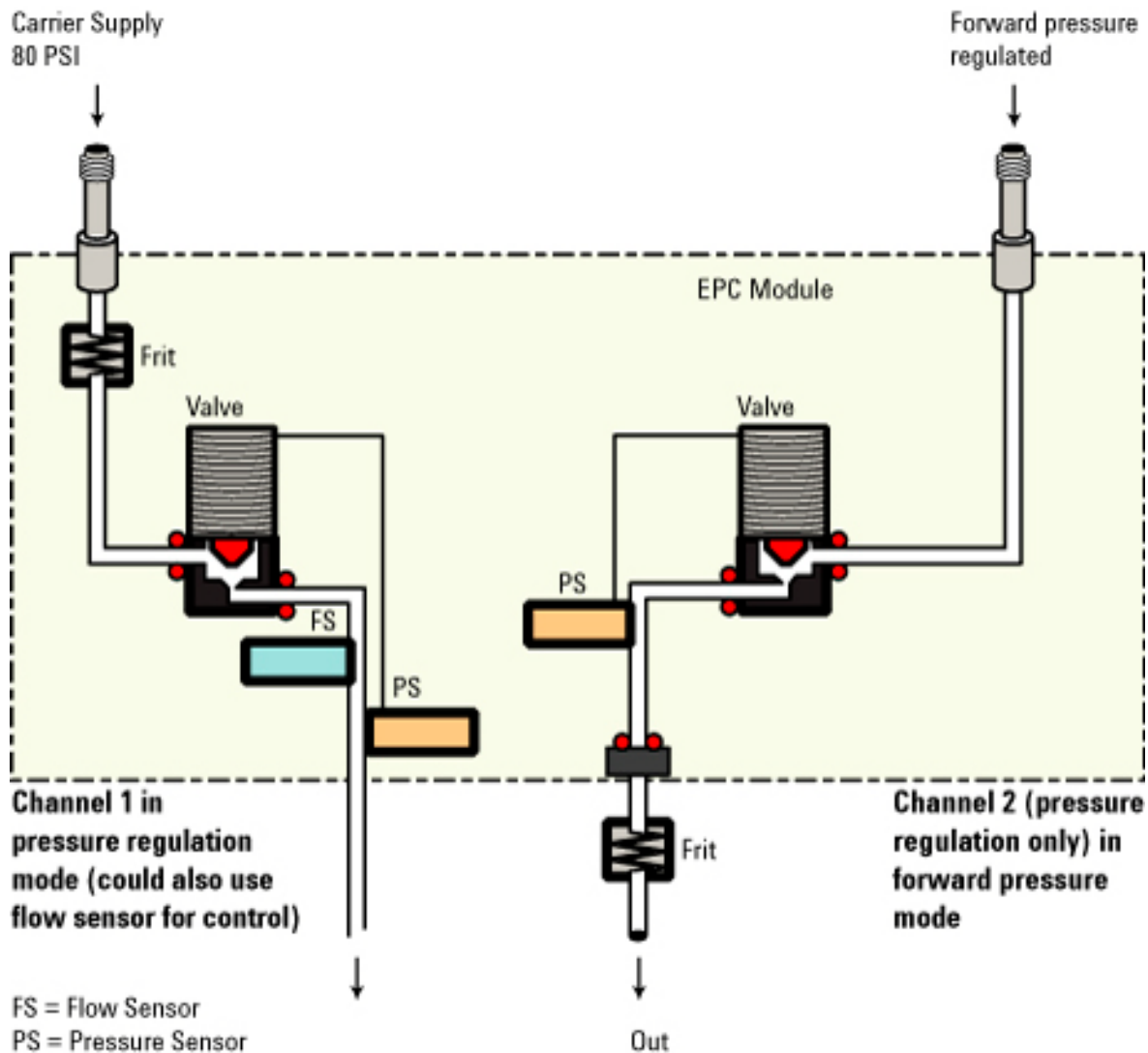

Channel 2 may be used either as a forward-pressure regulator or as a back-pressure regulator, simply by reversing the input and output connections. The back

pressure mode can be very useful with a gas sampling valve, where it ensures that the sample pressure in the loop remains constant.

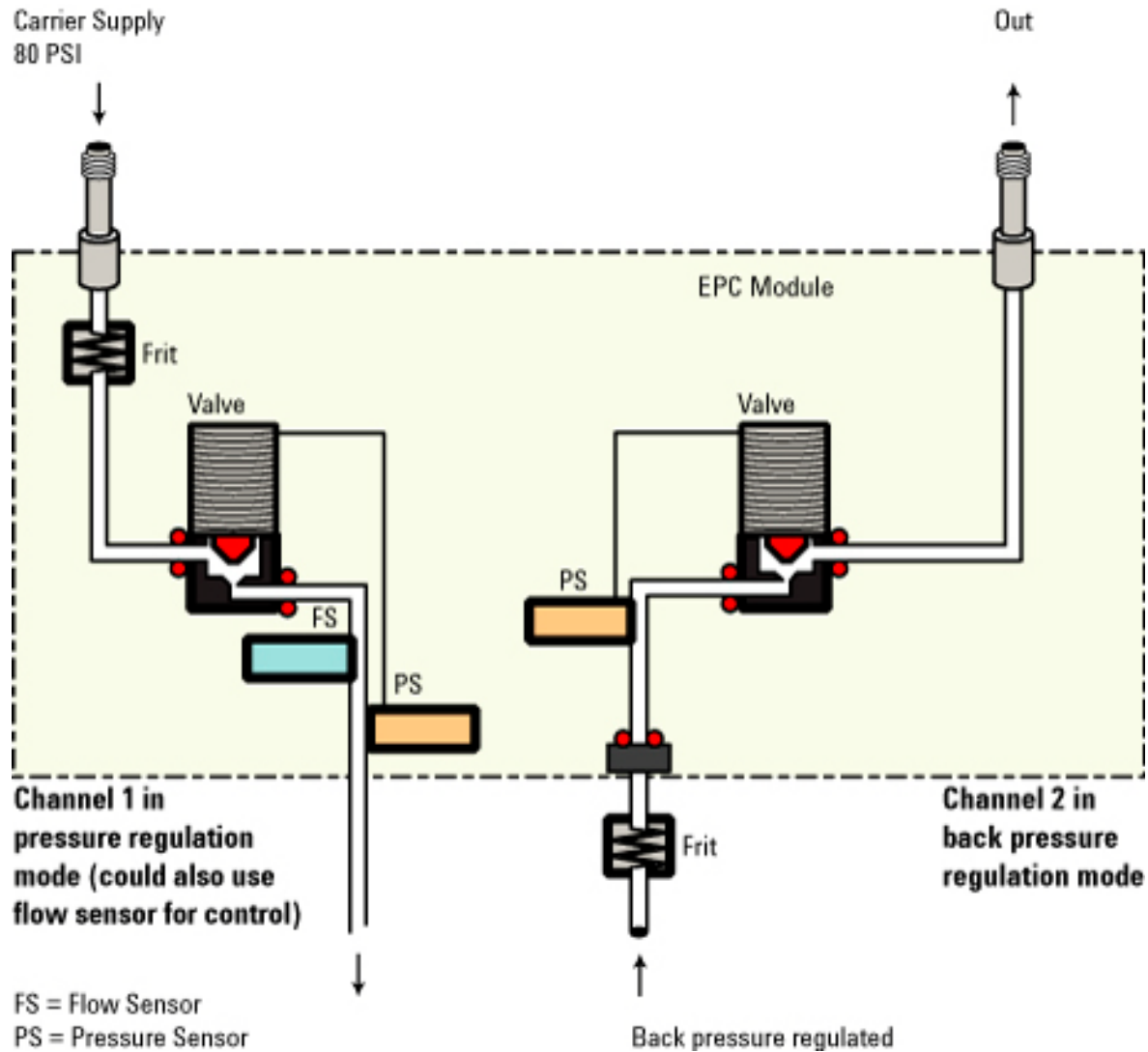

For channel 1, gas input is via a threaded fitting. Gas output is via a coil of metal tubing with a Swagelok fitting on the end.

For channel 2, the connections are the same as for channel 1 if channel 2 is to be used as a forward-pressure regulator. They are reversed—extra fittings/adapters will be needed—if it is to be used as a back-pressure regulator.

NOTE

The following discussion assumes that the PCM is connected to the communications cable available in its chassis slot.

PCMs can be installed in several locations:

- In slot 1. The name is **PCM A**. In this case, the PCM is connected to the connector labeled **EPC1**.
- In slot 2. The name is **PCM B**. In this case, the Aux EPC is connected to the connector labeled **EPC2**.
- In slot 5. If there are no PCMs in slots 1 and 2, the name is **PCM A**. If another PCM is installed in either slot 1 or 2, the PCM in slot 5 takes the name that is not being used (**A** or **B**). If PCMs are installed in both slots 1 and 2, the name is **PCM C**. In this case, the PCM is connected to the connector labeled **EPC5**.
- In slot 6. The name is always **PCM C**. In this case, the PCM is connected to the connector labeled **EPC6**.

PCM A or B	Slot 3	PCM A	Split vent trap and valve
PCM C	Slot 4	PCM B	

Back of GC

Both channels of a PCM are controlled by the same parameter list. The first two lines refer to channel 1, the remaining lines refer to channel 2.

Auxiliary Pressure Controllers

The Auxiliary Pressure Controller (Aux epc) is also a general purpose device. It has three independent forward-pressure regulated channels. Channels are designated by numbers 1 through 9 (there can be up to 3 Aux epcs), depending on where the module is installed.

If an auxiliary channel is specified as the **Inlet** during column configuration, that channel allows run time programming and three-ramp flow or pressure programming.

Gas input is via threaded fittings. Gas output is via coils of metal tubing with Swagelok fittings on the ends.

As you look at the module from the back of the GC, the channels are numbered from left to right according to this scheme:

- In slot 6. The name is **Aux epc #**, where # is 1, 2, or 3 and identifies the channel. In this case, the Aux EPC is connected to the connector labeled **EPC6**.
- In slot 5. The name is **Aux epc #**, where # is 4, 5, or 6 and identifies the channel. In this case, the Aux EPC is connected to the connector labeled **EPC5**.
- In any open slot. The name is **Aux epc #**, where # is 7, 8, or 9 and identifies the channel. In this case, the Aux EPC is connected to the connector labeled **AUX DET1** or **AUX DET2**.
- In the third detector side of the GC. The name is **Aux epc #**, where # is 7, 8, or 9 and identifies the channel. In this case, the Aux EPC is connected to the connector labeled **AUX DET1** or **AUX DET2**.





Slot 5	Slot 3	Slot 1	Split vent trap and valve
Slot 6	Slot 4	Slot 2	

Back of GC

Restrictors

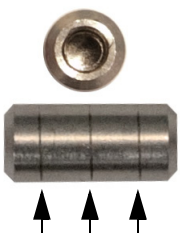
Both PCMs and auxiliary channels are controlled by pressure setpoints. To work properly, there must be adequate flow resistance downstream of the pressure sensor. Each channel provides a frit-type restrictor. Four frits are available.

Table 2 Auxiliary channel frits

Frit marking		Flow resistance	Flow characteristic	Often used with
Three rings Blue		High	3.33 ± 0.3 SCCM @ 15 PSIG	NPD Hydrogen
Two rings Red		Medium	30 ± 1.5 SCCM H2 @ 15 PSIG	FID Hydrogen
One ring Brown		Low	400 ± 30 SCCM AIR @ 40 PSIG	FID Air, FPD Air, QuickSwap, Splitter, Deans Switch
None (brass tube)		Zero	No restriction	Headspace vial pressurization

The one ring frit (low resistance, high flow) is installed in all channels in the AUX epc when the instrument (or accessory) is shipped. No frit ships in the PCM Aux channel.

When installing or replacing a frit, always use a new O-ring (5180-4181, 12/pk).

Selecting a frit

The frits change the control range of the channels. The objective is to find a frit that allows the required range of flows at reasonable source pressures.

- For an auxiliary channel ordered as an option (part of the GC order), use the frit supplied by the factory.
- For an auxiliary channel ordered as an accessory (separate from the GC order), see the instruction information supplied with the accessory.
- For a non-Agilent instrument, you must experiment to find the appropriate frit.

When you change a frit, you change the physical characteristics of the channel. It may be desirable (or necessary) to change the PID constants for that channel. See “PIDs” on page 21.

Examples

1. Using an Aux EPC channel to supply purge gas to a splitter

An Aux EPC channel operates only in the forward-pressure mode; it provides a constant pressure at its outlet. It is used to provide gas to some other device, such as a splitter with a makeup gas input.

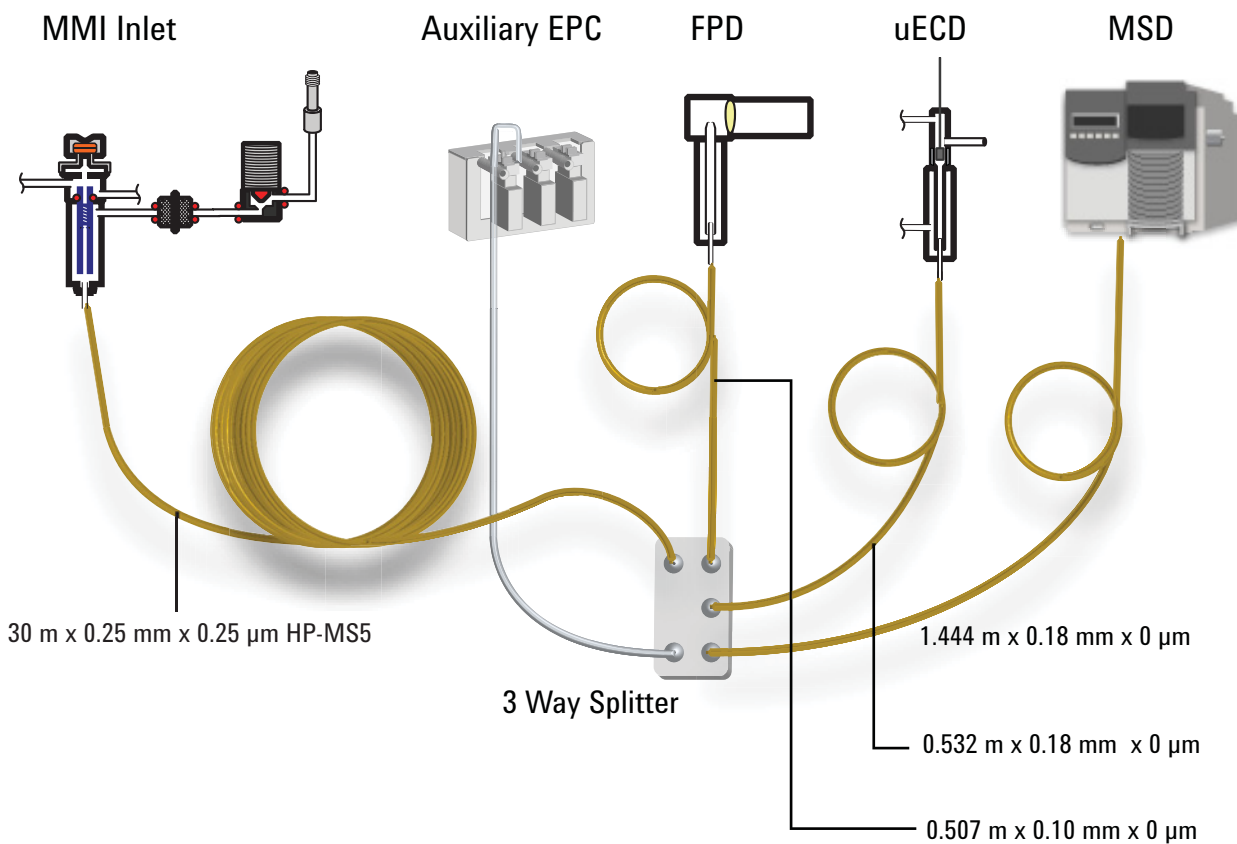

In this configuration, the gas eluting from the column is divided among three detectors. Because the resulting flows can be quite small, makeup gas is added at the splitter. An Aux EPC channel provides it.

Assume that we are using channel **Aux epc 1** as the makeup source. The gas is plumbed to the leftmost (as seen from the back of the GC) fitting on the proper module. The outlet tubing for this channel goes to the splitter inside the oven—an extension tube may be needed to reach this far.

The medium frit is probably appropriate for this application.

Rather than have the makeup gas flowing all the time, consider turning it on and off with run time commands.

2. Using the PCM channels

The two channels in a PCM are different. Channel 1 is used to *supply* a pressure. Channel 2 may be used in the same way, but can also be used to *maintain* a pressure by reversing the input and output connections.

Channel 1: Forward-pressure only

This is identical to the carrier gas channel for the packed column inlet.

Channel 2: Two-way channel

If gas is supplied at the threaded connection and delivered by the tubing, this operates the same as channel 1. But the connections can be reversed—requiring some fittings—so that it will maintain the gas supplied to it at a fixed pressure. In this mode it behaves as a controlled leak.

This can be used to maintain the gas in a gas sampling valve at a fixed pressure, even if the supply varies somewhat. The result is improved reproducibility in sample amount.

The figure shows the connections with the valve in the Load position.

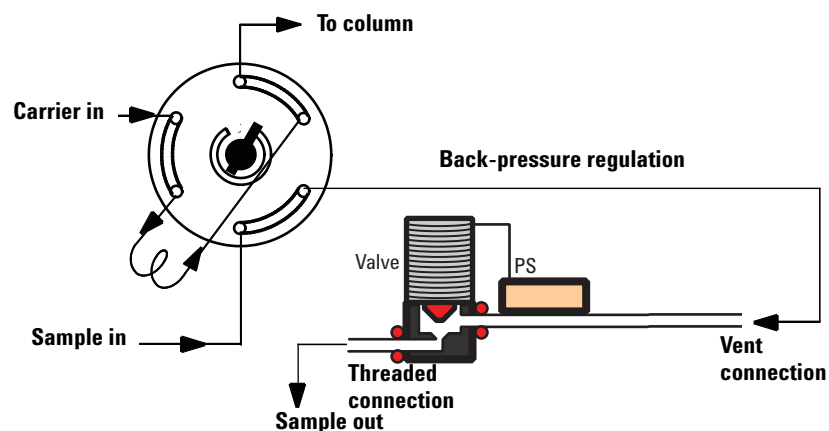

2 Flow and Pressure Modules



3 Inlets

- Using Hydrogen 35
- Inlet Overview 36
- Carrier Gas Flow Rates 37
- About Gas Saver 38
- Pre Run and Prep Run 40
 - Auto Prep Run 41
- About the Split/Splitless Inlet 42
 - Split/Splitless inlet split mode overview 43
 - Split/Splitless inlet splitless mode overview 44
 - The S/SL inlet pulsed split and splitless modes 45
 - Split/Splitless inlet split mode minimum operating pressures 46
 - Selecting the correct S/SL inlet liner 47
 - Vapor Volume Calculator 49
 - Selecting parameters for the S/SL splitless mode 50
- About the Multimode Inlet 53
 - Septum tightening (MMI) 53
 - Heating the MMI 54
 - Cooling the MMI 54
 - MMI split mode minimum operating pressures 55
 - Selecting the correct MMI liner 56
 - Vapor Volume Calculator 58
 - MMI split and pulsed split modes 58
 - MMI splitless and pulsed splitless modes 62
 - MMI solvent vent mode 68
 - MMI Direct Mode 76
 - To develop a MMI method that uses large volume injection 77
 - Multiple injections with the MMI 80
- About the Cool On-Column Inlet 90
 - Retention gaps 91
 - COC inlet temperature control 91
 - Setting COC inlet flows/pressures 92
- About the PTV Inlet 94
 - PTV sampling heads 94
 - Heating the PTV inlet 95
 - Cooling the PTV inlet 96



3 Inlets

- PTV inlet split and pulsed split modes [96](#)
- PTV inlet splitless and pulsed splitless modes [100](#)
- PTV inlet solvent vent mode [107](#)
- To develop a PTV method that uses large volume injection [115](#)
- Multiple injections with the PTV inlet [118](#)
- About the Volatiles Interface [124](#)
 - About the VI split mode [126](#)
 - About the VI splitless mode [130](#)
 - About the VI direct mode [135](#)
 - Preparing the Interface for Direct Sample Introduction [138](#)
 - Setting parameters for the VI direct mode [141](#)

Using Hydrogen

WARNING

When using hydrogen (H₂), as the carrier gas, be aware that hydrogen (H₂) gas can flow into the oven and create an explosion hazard. Therefore, be sure that the supply is off until all connections are made, and ensure that the inlet and detector column fittings are either connected to a column or capped at all times when hydrogen (H₂) gas is supplied to the instrument.

WARNING

Hydrogen (H₂) is flammable. Leaks, when confined in an enclosed space, may create a fire or explosion hazard. In any application using hydrogen (H₂), leak test all connections, lines, and valves before operating the instrument. Always turn off the hydrogen (H₂) supply at its source before working on the instrument.

Inlet Overview

Table 3 Comparing inlets

Inlet	Column	Mode	Sample concentration	Comments	Sample to column
Split/splitless	Capillary	Split	High	Useful with large injections	Very little
		Pulsed split	High		Very little
		Splitless	Low	Useful with large injections	All
		Pulsed splitless	Low		All
Multimode	Capillary	Split	High	Multiple injections concentrate analytes and vent solvent	Very little
		Pulsed split	High		Very little
		Splitless	Low		All
		Pulsed splitless	Low		All
		Solvent vent	Low		Most
		Direct			All
Cool on-column	Capillary	n/a	Low or labile	Minimal discrimination and decomposition	All
Packed column	Packed	n/a	Any	OK if resolution not critical	All
	Large capillary	n/a	Any		All
Programmed temperature vaporization	Capillary	Split	High	Multiple injections concentrate analytes and vent solvent	Very little
		Pulsed split	High		Very little
		Splitless	Low		All
		Pulsed splitless	Low		All
		Solvent vent	Low		Most
Volatiles interface (for use with external volatiles sampler)	Capillary	Direct	Low	Lowest dead volume Max flow = 100 mL/min	All
		Split	High		Very little
		Splitless	Low		All

Carrier Gas Flow Rates

The flow rates in [Table 4](#) are recommended for all column temperatures.

Table 4 Column size and carrier flow rate

Column type	Column size	Carrier flow rate, mL/min		
		Hydrogen	Helium	Nitrogen
Packed	1/8-inch		30	20
	1/4-inch		60	40
Capillary	0.05 mm id	0.5	0.4	n/a
	0.10 mm id	1.0	0.8	n/a
	0.20 mm id	2.0	1.6	0.25
	0.25 mm id	2.5	2.0	0.5
	0.32 mm id	3.2	2.6	0.75
	0.53 mm id	5.3	4.2	1.5

About Gas Saver

Gas saver reduces carrier flow from the split vent after the sample is on the column. It applies to the Split/Splitless and PTV inlets (all modes) and to the split and splitless modes of the Volatiles Interface. It is most useful in split applications.

Column head pressure and flow rate are maintained, while purge and split vent flows decrease. Flows—except column flow—remain at the reduced level until you press **[Prep Run]**.

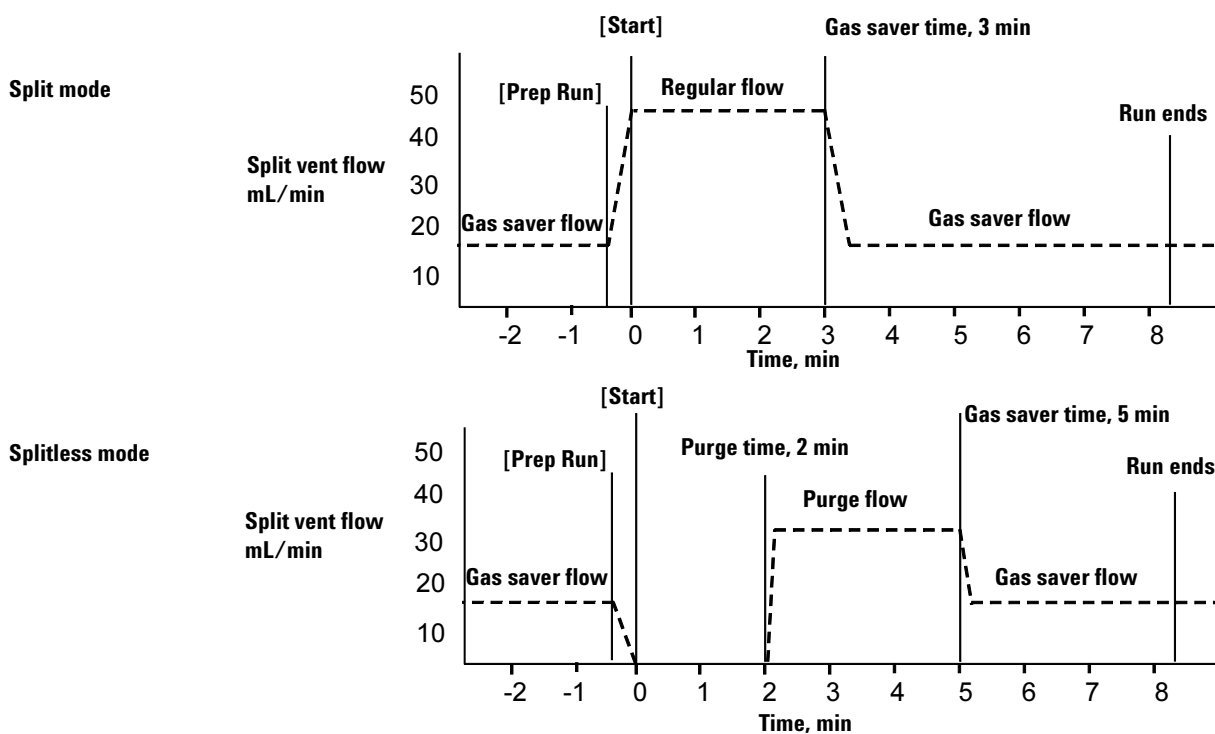

The pulsed modes of the split/splitless and PTV inlets are similar except for the pressure pulse starting at **[Prep Run]** and ending at **Pulse time**. The solvent vent mode of the PTV is more complex; see [“PTV inlet solvent vent mode”](#).

To use gas saver

- 1 Press [**Front Inlet**] or [**Back Inlet**].
- 2 Turn gas saver **On**.
- 3 Set **Gas saver flow**. It must be at least 15 mL/min greater than the column flow.
- 4 If in split mode, set **Saver time** after injection time. In all other modes, set after **Purge time**.

Pre Run and Prep Run

With some inlets and operating modes, certain instrument setpoints are different between runs than during an analysis. To restore the setpoints for injection, you must place the GC into the Pre Run state.

You must use the Pre Run state when:

- Using gas saver with any inlet.
- Using splitless mode with any inlet.
- Using a pressure pulse mode with any inlet.
- Using the solvent vent mode of the PTV inlet.
- Using the direct or splitless mode of the Volatiles Interface.

There are three ways to begin Pre Run—manually (press **[Prep Run]** before each run), automatically (for Agilent samplers), or using **Auto Prep Run** (for non-Agilent samplers). The three methods are discussed below.

During the Pre Run state:

- The Pre Run light blinks and Not Ready is on.
- Setpoints change to the correct values for injection.
- Inlet, detector, and oven equilibration times begin.

When all equilibration times expire, the Pre Run light is on steadily. When all criteria for a run are met, the Not Ready light turns off. The GC is now ready for sample injection.

The **[Prep Run]** key

Press **[Prep Run]** before you inject a sample manually. The GC enters the Pre Run state. When the Pre Run light is steady and the Not Ready light goes off, begin the analysis.

Agilent samplers

If you are using an Agilent automatic sampling system, the **[Prep Run]** function is automatic.

Start the sampler. It generates the **[Prep Run]** function. When all the setpoints are reached and the GC becomes Ready, sample injection begins.

Non-Agilent samplers

With most automatic injection systems, you do not need to use the **[Prep Run]** key. If your sampler or automation controller (for example, an integrator or workstation) does not support the **[Prep Run]** function, you must set the GC to **Auto Prep Run**.

Auto Prep Run

To set this parameter, usually for a non-Agilent integrator, workstation, or other controlling device:

- 1 Press **[Config]** to view a list of configurable parameters.
- 2 Scroll to **Instrument** and press **[Enter]**.
- 3 Scroll to **Auto prep run** and press **[On/Yes]**.

About the Split/Splitless Inlet

This inlet is used for split, splitless, pulsed splitless, or pulsed split analyses. You can choose the operating mode from the inlet parameter list. The *split mode* is generally used for major component analyses, while the *splitless mode* is used for trace analyses. The *pulsed splitless* and *pulsed split modes* are used for the same type of analyses as split or splitless, but allow you to inject larger samples.

Septum tightening (S/SL)

Septum retainer nuts must be tightened enough to obtain a good gas seal, but not so much as to compress the septum and make it difficult to push a syringe needle through it.

For the standard septum retainer nut, an internal spring in the septum retainer applies pressure to the septum. For inlet pressures up to 100 psi, tighten the retainer until the C-ring lifts about 1 mm above the top surface. This is adequate for most situations.

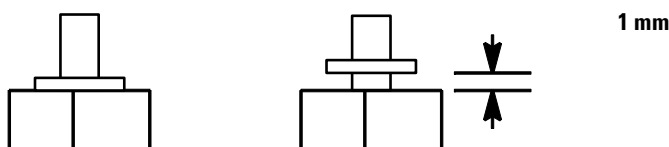

With higher inlet pressures, tighten the septum retainer until the C-ring stops turning, indicating that the retainer is in firm contact with the septum.

If using a Merlin Microseal™ septum, finger tighten the septum nut, until snug (not loose). The pressure capacity depends on the duckbill seal used.

Standard and high-pressure versions of the S/SL inlet

The standard split/splitless inlet is rated to 100 psi pressure at the inlet. It is appropriate for most columns. The high-pressure inlet is rated to 150 psi pressure—it is useful with very small diameter capillary columns that offer considerable resistance to gas flow.

Recommended source pressures are 120 psi and 170 psi respectively.

To determine the version that you have, press [**Front Inlet**] or [**Back Inlet**], scroll to the **Pressure** line, and press the [**Info**] key. The display will show the pressure range for the inlet—either **1 to 100 psi** (for the standard version) or **1 to 150 psi** (for the high-pressure version).

Split/Splitless inlet split mode overview

During a split injection, a liquid sample is introduced into a hot inlet where it vaporizes rapidly. A small amount of the vapor enters the column while the major portion exits from the split/purge vent. The ratio of column flow to split vent flow is controlled by the user. Split injections are primarily used for high concentration samples when you can afford to lose most of the sample out the split/purge vent. It is also used for samples that cannot be diluted.

The **split ratio** is equal to the split vent flow divided by the column flow. If the column has been configured, the desired split ratio can be entered directly.

The pneumatics for this inlet in split mode operation are shown in the figure below.

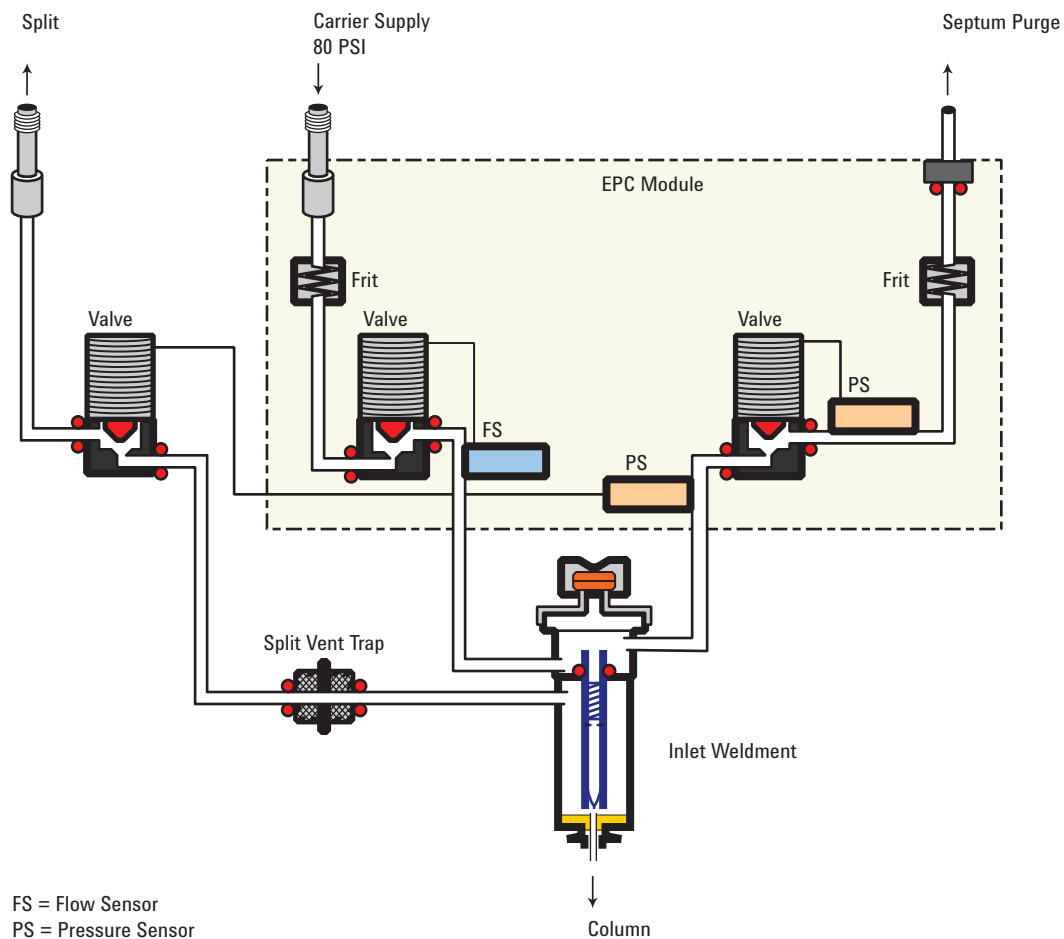

Split/Splitless inlet splitless mode overview

In this mode, the split vent valve is closed during the injection and remains so while the sample is vaporized in the liner and transferred to the column. At a specified time after injection, the valve opens to sweep any vapors remaining in the liner out the split vent. This avoids solvent tailing due to the large inlet volume and small column flow rate. Specify the purge time and purge flow rate in the inlet parameter list.

The septum purge flow may be either on at all times (Standard mode) or on only between the purge time and the end of the run (Switched mode).

If you are using gas saver, the gas saver time should be *after* the purge time.

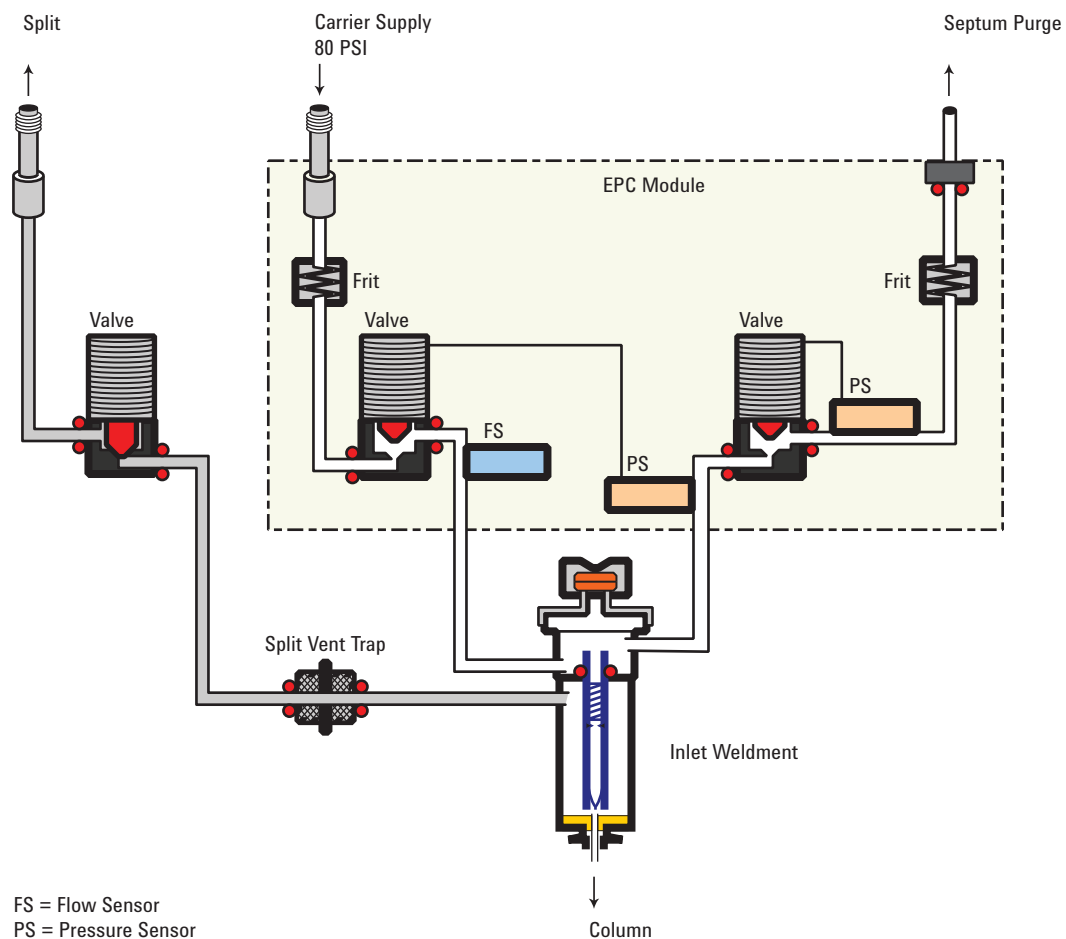

The S/SL inlet pulsed split and splitless modes

The pressure pulse modes increase inlet pressure just before the beginning of a run and return it to the normal value after a specified amount of time. The pressure pulse:

- reduces the solvent vapor volume
- reduces the risk of inlet overload
- tightens the sample band
- may allow use of a 2 mm liner, reducing the active glass area

If your chromatography is degraded by the pressure pulse, a retention gap may help restore peak shape.

You must press **[Prep Run]** before doing manual injections in the pressure pulse modes. See “[Pre Run and Prep Run](#)” on page 40 for details.

You can do column pressure and flow programming when in the pressure pulse mode. However, the pressure pulse will take precedence over the column pressure or flow ramp.

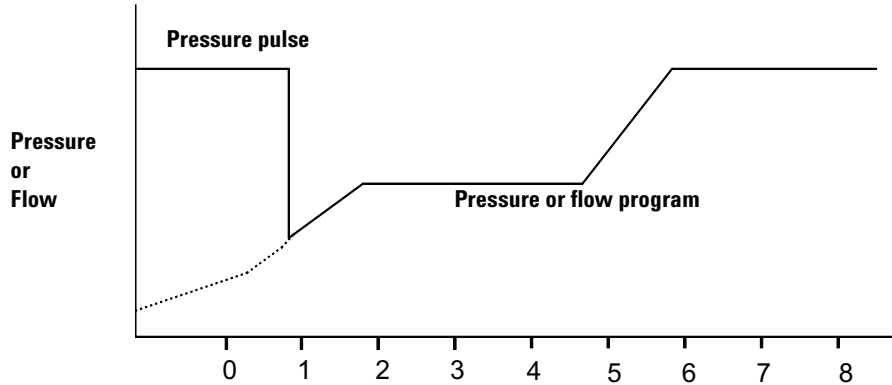

Split/Splitless inlet split mode minimum operating pressures

The minimum recommended inlet total flow is 20 mL/minute. When the split/splitless inlet is operated in Split mode, there will be a minimum pressure at which the inlet can operate. Typically, low inlet pressures may be required for shorter, wide bore columns. The minimum pressure is a function of carrier gas type, total inlet flow, liner design, and possible contamination of the split vent tube or trap.

A wide bore column requires a much lower inlet pressure than a typical capillary column to maintain a given flow. Setting the split ratio (total flow) too high when using a wide bore column can create an unstable control relationship between the pressure and flow control loops.

Table 5 Approximate minimum viable inlet pressures for split/splitless inlet in split mode, in psi (kPa)

	Split vent flow (mL/min)			
	50–100	100–200	200–400	400–600
Helium and hydrogen carrier gases				
Split liners - 5183-4647, 19251-60540	2.5 (17.2)	3.5 (24.1)	4.5 (31)	6.0 (41.4)
Splitless liners - 5062-3587, 5181-8818	4.0 (27.6)	5.5 (37.9)	8.0 (55.2)	11.0 (75.4)
Nitrogen carrier gas				
Split liners - 19251-60540, 5183-4647	3.0 (20.7)	4.0(27.6)	—	—
Splitless liners - 5062-3587, 5181-8818	4.0 (27.6)	6.0 (41.4)	—	—





These numbers are based on the resistance to flow of new, clean inlet systems. Sample condensation in the split vent tube or a dirty filter can make these values non-attainable.

Selecting the correct S/SL inlet liner

Split liner

A good liner for split mode operation will offer very little restriction to the split flow path between the bottom of the liner and the inlet gold seal and between the outside of the liner and the inside of the injection port body. The preferred Agilent split liner, part number 5183-4647, incorporates a glass positioning bead on the bottom to facilitate this. It will also incorporate glass wool or some other source of surface area inside the liner that provides for complete sample vaporization across the boiling point range of the sample. Select an appropriate liner from [Table 6](#).

Table 6 Split mode liners

Liner	Description	Volume	Mode	Deactivated	Part Number
	Low Pressure Drop – Positioning Bead	870 µL	Split – Fast Injection	Yes	5183-4647
	4mm ID, Glass Wool	990 µL	Split – Fast Injection	No	19251-60540
	Empty Pin & Cup	800 µL	Split – Manual Only	No	18740-80190
	Packed Pin & Cup	800 µL	Split – Manual Only	No	18740-60840

Splitless liner

The liner volume must contain the solvent vapor. The liner should be deactivated to minimize sample breakdown during the purge delay. Solvent vapor volume can be reduced by using Pulsed Splitless mode. Use the [“Vapor Volume Calculator”](#) to determine vapor volume requirements.

Vapor volume < 300 µL Use 2 mm liner (250 µL volume), 5181-8818 or similar.











Vapor volume 225 – 300 µL Consider pulsed splitless mode to reduce vapor volume.

Vapor volume > 300 µL Use 4 mm liner, 5062-3587 or similar.

Vapor volume > 800 µL Consider pulsed splitless mode to reduce vapor volume.

For thermally labile or reactive samples, use G1544-80700 (open top) or G1544-80730 (top taper) liners.

Table 7 Splitless mode liners

Liner	Description	Volume	Mode	Deactivated	Part Number
	Single Taper Glass Wool	900 uL	Splitless	Yes	5062-3587
	Single Taper	900 uL	Splitless	Yes	5181-3316
	Dual Taper	800 uL	Splitless	Yes	5181-3315
	2 mm Quartz	250 uL	Splitless	No	18740-80220
	2 mm Quartz	250 uL	Splitless	Yes	5181-8818
	1.5 mm	140 uL	Direct Inject, Purge and Trap, Headspace	No	18740-80200
	Single Taper Glass Wool	900 uL	Splitless	Yes	5062-3587
	Single Taper	900 uL	Splitless	Yes	5181-3316
	4 mm Single Taper	Direct column connect		Yes	G1544-80730
	4 mm Dual Taper	Direct column connect		Yes	G1544-80700

Vapor Volume Calculator

Agilent provides a Vapor Volume Calculator to help you determine if a liner is suitable for a method. To use the calculator install the Agilent Instrument utility provided with the GC. The calculator is also provided with the Agilent Instrument Utilities software.

Setting parameters for the S/SL split mode

Mode The current operating mode—split

Temperature Actual and setpoint inlet temperatures

Pressure Actual and setpoint inlet pressure

Split ratio The ratio of split vent flow to column flow. Column flow is set at the Column parameter list. This line appears only if your columns in the flow path are defined.

Split flow Flow, in mL/min, from the split vent. This line appears only if your columns in the flow path are defined.

Total flow This is the total flow into the inlet, which is the sum of the split vent flow, column flow, and septum purge flow. When you change the total flow, the split ratio and split vent flow change while the column flow and pressure remain the same.

Septum Purge Flow, in mL/min, through the septum purge line. Recommended range is 1 to 5 mL/min.

If all columns in the flow path are defined

- 1 Press [**Front Inlet**] or [**Back Inlet**].
- 2 Scroll to **Mode:** and press [**Mode/Type**]. Select **Split**.
- 3 Set the inlet temperature.
- 4 If you want a specific split ratio, scroll to **Split ratio** and enter that number. **Split flow** will be calculated for you.
- 5 If you want a specific split flow, scroll to **Split flow** and enter that number. **Split ratio** will be calculated for you.
- 6 If desired, turn on **Gas saver**. Set **Saver time** after the injection time. Press [**Prep Run**] (see “[Pre Run and Prep Run](#)” on page 40) before manually injecting the sample.

If a column in the flow path is not defined

- 1 Press [**Front Inlet**] or [**Back Inlet**].
- 2 Set the inlet temperature.
- 3 Set **Total flow** into the inlet. It must exceed your intended **Septum Purge** flow. Measure the split vent flow using a flow meter.
- 4 Subtract split vent flow and septum purge flow (see “[Pre Run and Prep Run](#)” on page 40) from **Total flow** to get column flow.
- 5 Calculate the split ratio (split vent flow/column flow). Adjust as needed.

Selecting parameters for the S/SL splitless mode

A successful splitless injection consists of these steps:

- 1 Vaporize the sample and solvent in a heated inlet.
- 2 Use a low flow and low oven temperature to create a solvent-saturated zone at the head of the column.
- 3 Use this zone to trap and reconcentrate the sample at the head of the column.
- 4 Wait until all, or at least most, of the sample has transferred to the column. Then discard the remaining vapor in the inlet—which is mostly solvent—by opening a purge valve. This eliminates the long solvent tail that this vapor would otherwise cause.
- 5 Raise the oven temperature to release the solvent and then the sample from the head of the column.

Some experimentation is needed to refine the operating conditions. [Table 8](#) provides starting values for the critical parameters.

Table 8 Splitless mode inlet parameters

Parameter	Allowed setpoint range	Suggested starting value
Oven temperature	No cryo, 24 °C to 450 °C CO ₂ cryo, –60 °C to 450 °C N ₂ cryo, –80 °C to 450 °C	10 °C below solvent boiling point
Oven initial time	0 to 999.9 minutes	≥ Inlet purge time
Inlet purge time	0 to 999.9 minutes	$\frac{2 \times \text{Liner volume}}{\text{Column flow}}$

Table 8 Splitless mode inlet parameters

Parameter	Allowed setpoint range	Suggested starting value
Gas saver time	0 to 999.9 minutes	After purge time
Gas saver flow	15 to 1000 mL/min	15 mL/min greater than maximum column flow

Setting parameters for the S/SL splitless mode

Mode The current operating mode—splitless

Oven temperature Below solvent boiling point

Temperature Actual and setpoint inlet temperatures

Pressure Actual and setpoint inlet pressure in psi, bar, or kPa

Purge time The time, after the beginning of the run, when you want the purge valve to open. This is the time in which the vaporized sample transfers from the liner to the column.

Purge flow The flow, in mL/min, from the purge vent, at **Purge time**. You will not be able to specify this value if any column in the flow path is not defined.

Total flow The actual flow to the inlet during a Pre-run (Pre-run light is on and not blinking) and during a run before purge time. You cannot enter a setpoint at these times. At all other times, **Total flow** will have both setpoint and actual values.

Septum Purge Flow, in mL/min, through the septum purge line.

Septum Purge Flow Mode Standard (septum purge flow is On at all times) or Switched (septum purge flow is Off during injection, turns On at Purge time).

If all columns in the flow path are defined

- 1 Press **[Front Inlet]** or **[Back Inlet]**.
- 2 Scroll to **Mode:** and press **[Mode/Type]**. Select **Splitless**.
- 3 Set the inlet temperature.

- 4 Enter a **Purge time** and a **Purge flow**.
- 5 If desired, turn on **Gas saver**. Make certain the time is set after the **Purge time**.
- 6 Press [**Prep Run**] (see “[Pre Run and Prep Run](#)” on page 40) before manually injecting a sample (this is automatic for Agilent ALS).

If a column in the flow path is not defined

- 1 Press [**Front Inlet**] or [**Back Inlet**].
- 2 Scroll to **Mode:** and press [**Mode/Type**]. Select **Splitless**.
- 3 Set the inlet temperature.
- 4 Enter a **Purge time**.
- 5 Set your **Total flow** greater than the sum of column flow plus the septum purge flow—see “[Pre Run and Prep Run](#)” on page 40—to guarantee adequate column flow.
- 6 Press [**Prep Run**] (see “[Pre Run and Prep Run](#)” on page 40) before manually injecting a sample.

Setting parameters for the S/SL pulsed modes

The pulsed mode parameters are the same as the non-pulsed parameters, but with two additional values.

Pulsed pressure The inlet pressure you want at the start of the run. The pressure rises to this value when [**Prep Run**] is pressed and remains constant until **Pulse time** elapses, when it returns to **Pressure**.

Pulse time This is the time after the start of the run when the inlet pressure returns to **Pressure**.

About the Multimode Inlet

The Agilent Multimode (MMI) Inlet System has five operating modes:

- The *split mode* is generally used for major component analyses.
- The *pulsed split mode* is like the split mode, but with a pressure pulse applied to the inlet during sample introduction to speed the transfer of material to the column.
- The *splitless mode* is used for trace analyses.
- The *pulsed splitless mode* allows for a pressure pulse during sample introduction.
- The *solvent vent mode* is used for large volume injection. Either single or multiple injections can be made for each run.
- The *direct mode* allows for a direct forward pressure of carrier gas through the column. The split vent valve is closed.

The MMI can be used with both manual and automatic injection.

Automatic multiple injections (large volume injections) is not available under GC control alone. See “[MMI solvent vent mode](#)” on page 68.

Septum tightening (MMI)

Septum retainer nuts must be tightened enough to obtain a good gas seal, but not so much as to compress the septum and make it difficult to push a syringe needle through it.

For the standard septum retainer nut, an internal spring in the septum retainer applies pressure to the septum. For inlet pressures up to 100 psi, tighten the retainer until the C-ring lifts about 1 mm above the top surface. This is adequate for most situations.

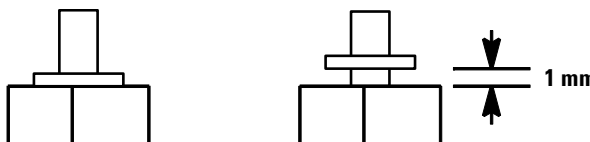

With higher inlet pressures, tighten the septum retainer until the C-ring stops turning, indicating that the retainer is in firm contact with the septum.

If using a Merlin Microseal™ septum, finger tighten the septum nut, until snug (not loose). The pressure capacity depends on the duckbill seal used.

Heating the MMI

Programming the MMI temperature is similar to programming the column oven. Access the inlet parameters by pressing [**Front Inlet**] or [**Back Inlet**]. Temperature can be programmed with an initial temperature and up to 10 ramps (rates and plateaus). See “[MMI split and pulsed split modes](#)” for details.

At the end of the run and during post-run, the MMI is held at its final temperature. This permits backflushing without contaminating the inlet.

Additional temperature ramps

For most purposes, the MMI is designed to hold the sample in the inlet liner until the entire sample—there could be several injections—has been injected. Then the MMI is heated rapidly to transfer the sample to the column. This can be accomplished with an initial hold, a single ramp, and a hold at the end to complete sample transfer.

Additional ramps are available and have several possible uses:

- The inlet can be heated to a high temperature to thermally clean the liner for the next run.
- The inlet can be programmed downward—just set the Final temp below the previous temperature—to reduce thermal stress on the inlet.
- Downward programming can be used to prepare the inlet for the next run. This can reduce cycle time for greater sample throughput.

Cooling the MMI

If using cryogen to cool the MMI inlet, both liquid carbon dioxide (LCO₂) and liquid nitrogen (LN₂) are supported. In addition to the cryogenic coolants, the MMI supports compressed air cooling on both the LCO₂ and LN₂ cooling options for legacy applications.

If using cryo as the coolant when configuring the initial inlet setpoint, set the **Use cryo temperature** equal to or higher than the inlet setpoint to cool the inlet and hold the setpoint until the inlet temperature program exceeds the **Use cryo temperature**. If the **Use cryo temperature** is less than the inlet setpoint, cryogen will cool the inlet to the initial setpoint and turn off.

If using compressed air as the coolant when configuring the initial inlet setpoint, **Use cryo temperature** behaves differently when in **Compressed air** mode than it does when in **N2 cryo** or **CO2 cryo** mode. In **Compressed air** mode, the air coolant is used to cool the inlet regardless of the **Use cryo temperature** setpoint during the cooling cycle. If the inlet reaches setpoint, the air coolant is turned off and stays off. If the oven temperature is high enough or the inlet was very hot previously, it is possible that the inlet temperature will rise and the GC will go not ready. For this reason, it is better to set the instrument cooling configuration as **N2 cryo** or **CO2 cryo** when using compressed air as the coolant. When using compressed air, the LN₂ hardware cools the inlet faster than the LCO₂ hardware. Never use LCO₂ or LN₂ when the instrument is configured in **Compressed air** mode.

If cryo is turned on, and if the inlet is cooled during a run, cryogen is used to achieve the setpoint. This may have a negative impact on the chromatographic performance of the oven and cause distorted peaks.

When a method ends, the cooling setpoint returns to the initial state of the method, unless you load another method. To conserve coolant when the GC is idle, load a method that does not use a cooling configuration.

MMI split mode minimum operating pressures

The minimum recommended inlet total flow is 20 mL/minute. When the inlet is operated in a Split mode, there will be a minimum pressure at which the inlet can operate. Typically, low inlet pressures may be required for shorter, wide bore columns. The minimum pressure is a function of carrier gas type, total inlet flow, liner design, and possible contamination of the split vent tube or trap.

A wide bore column requires a much lower inlet pressure than a typical capillary column to maintain a given flow. Setting the split ratio (total flow) too high when using a wide bore column can create an unstable control relationship between the pressure and flow control loops.

Table 9 Approximate minimum viable inlet pressures for MMI in split mode, in psi (kPa)

	Split vent flow (mL/min)			
	50–100	100–200	200–400	400–600
Helium and hydrogen carrier gases				
Split liners - 5183-4647, 19251-60540	2.5 (17.2)	3.5 (24.1)	4.5 (31)	6.0 (41.4)
Splitless liners - 5062-3587, 5181-8818	4.0 (27.6)	5.5 (37.9)	8.0 (55.2)	11.0 (75.4)
Nitrogen carrier gas				
Split liners - 19251-60540, 5183-4647	3.0 (20.7)	4.0(27.6)	—	—
Splitless liners - 5062-3587, 5181-8818	4.0 (27.6)	6.0 (41.4)	—	—





These numbers are based on the resistance to flow of new, clean inlet systems. Sample condensation in the split vent tube or a dirty filter can make these values non-attainable.

Selecting the correct MMI liner

Split liner

A good liner for split mode operation will offer very little restriction to the split flow path between the bottom of the liner and the inlet body and between the outside of the liner and the inside of the inlet body. The preferred Agilent split liner, part number 5183-4647, incorporates a glass positioning bead on the bottom to facilitate this. It will also incorporate glass wool or some other source of surface area inside the liner that provides for complete sample vaporization across the boiling point range of the sample. Select an appropriate liner from [Table 10](#).

Table 10 Split mode liners

Liner	Description	Volume	Mode	Deactivated	Part Number
	Low Pressure Drop – Positioning Bead	870 µL	Split – Fast Injection	Yes	5183-4647
	4mm ID, Glass Wool	990 µL	Split – Fast Injection	No	19251-60540
	Empty Pin & Cup	800 µL	Split – Manual Only	No	18740-80190
	Packed Pin & Cup	800 µL	Split – Manual Only	No	18740-60840

Splitless liner

The liner volume must contain the solvent vapor. The liner should be deactivated to minimize sample breakdown during the purge delay. Solvent vapor volume can be reduced by using Pulsed Splitless mode. Use the “[Vapor Volume Calculator](#)” to determine vapor volume requirements.

Vapor volume < 300 μL Use 2 mm liner (250 μL volume), 5181-8818 or similar.

Vapor volume 225 – 300 μL Consider pulsed splitless mode to reduce vapor volume.

Vapor volume > 300 μL Use 4 mm liner, 5062-3587 or similar.

Vapor volume > 800 μL Consider pulsed splitless mode to reduce vapor volume.

For thermally labile or reactive samples, use G1544-80700 (open top) or G1544-80730 (top taper) liners.

Table 11 Splitless mode liners











Liner	Description	Volume	Mode	Deactivated	Part Number
	Single Taper Glass Wool	900 μL	Splitless	Yes	5062-3587
	Single Taper	900 μL	Splitless	Yes	5181-3316
	Dual Taper	800 μL	Splitless	Yes	5181-3315
	2 mm Quartz	250 μL	Splitless	No	18740-80220
	2 mm Quartz	250 μL	Splitless	Yes	5181-8818
	1.5 mm	140 μL	Direct Inject, Purge and Trap, Headspace	No	18740-80200
	Single Taper Glass Wool	900 μL	Splitless	Yes	5062-3587
	Single Taper	900 μL	Splitless	Yes	5181-3316
	4 mm Single Taper	Direct column connect		Yes	G1544-80730

Table 11 Splitless mode liners (continued)

Liner	Description	Volume	Mode	Deactivated	Part Number
	4 mm Dual Taper	Direct column connect		Yes	G1544-80700

Vapor Volume Calculator

Agilent provides a Vapor Volume Calculator to help you determine if a liner is suitable for a method. To use the calculator install the Agilent Instrument utility provided with the GC. The calculator is also provided with the Agilent Instrument Utilities software.

MMI split and pulsed split modes

The two split modes—with or without a pressure pulse—divide the gas stream entering the inlet between the column flow and the split vent flow through the solenoid valve. The ratio of the split vent flow to the column flow is called the split ratio.

The next figure shows the flows with split and pulsed split modes.

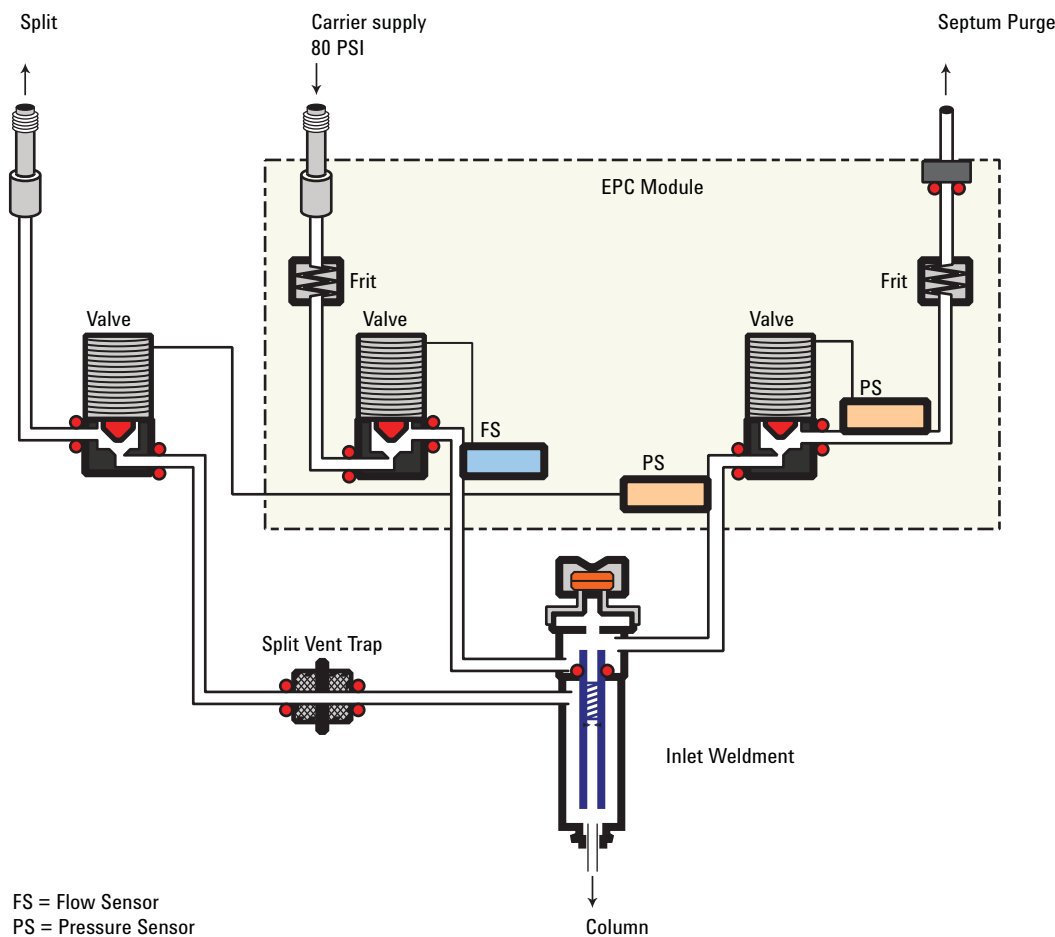

Cold split introduction

For cold split sample introduction, use an initial inlet temperature below the normal boiling point of the solvent. If the liner volume is enough to hold all the vaporized solvent, start the first inlet temperature ramp at 0.1 minutes with a high heating rate (500 °C/min or higher). The final temperature should be high enough to volatilize the heaviest analytes from the liner and should be held for at least 5 minutes. A final temperature of 350 °C for 5 minutes has proven sufficient to quantitatively transfer C₄₄.

For larger injection volumes or to eliminate the solvent, hold the initial temperature long enough to vent the solvent through the split vent and then begin the first ramp. Use a fast rate for thermally stable analytes. Slower rates may help minimize thermal degradation in the inlet.

A single temperature ramp is enough for the injection process. The remaining ramps may be used to clean the liner or to reduce the inlet temperature in preparation for the next injection.

Hot split introduction

For hot split introduction, set an initial temperature high enough to volatilize the analytes. No additional thermal parameters are required as the inlet will maintain the setpoint throughout the run.

Setting parameters for split mode operation

Mode: The current operating mode—split or pulsed split

Temperature Actual and setpoint inlet temperatures.

Initial temperature Starting temperature for the inlet.

Initial time Hold time at the inlet initial temperature.

Rate # Temperature program rates for inlet thermal ramps.

Final temp # Final inlet temperature for ramp 1-10.

Final time # Hold time at Final temp 1-10.

Pressure Actual and setpoint inlet pressure. Controls capillary column flow and linear velocity.

Split ratio The ratio of split flow to column flow. Column flow is set in the column parameter list. This line does not appear if a column in the flow path is not defined.

Split flow Flow, in mL/min, from the split/purge vent. This line does not appear if a column in the flow path is not defined.

Total flow These are the actual and setpoint values of the total flow into the inlet, which is the sum of the split flow, column flow, and septum purge flow. When you change the total flow, the split ratio and split flow change while the column flow and pressure remain the same.

Septum Purge Flow through the septum purge vent.

Gas saver On to reduce split vent flow at **Saver time**.

Saver flow Reduced split vent flow, at least 15 mL/min.

Saver time Time when flow is reduced to save gas.

If all columns in the flow path are defined

- 1 Press [**Front Inlet**].
- 2 Scroll to **Mode:** and press [**Mode/Type**]. Select **Split** or **Pulsed split**.
- 3 Set the inlet temperature (**Initial temperature**) and any desired ramps.
- 4 If you want a specific split ratio, scroll to **Split ratio** and enter that number. The split flow will be calculated and set for you.
- 5 If you want a specific split flow, scroll to **Split flow** and enter that number. The split ratio will be calculated and displayed for you.
- 6 If you selected **Pulsed split**, enter values for **Pulsed pressure** (pressure at injection) and **Pulse time** (minutes after injection to return to normal pressure).
- 7 If desired, turn on **Gas saver**. Set the **Saver time** after the injection time.
- 8 Press [**Prep Run**] before manually injecting the sample if the Gas Saver is on (see “[Pre Run and Prep Run](#)” on page 40 for details.).

If a column in the flow path is not defined

- 1 Press [**Front Inlet**].
- 2 Set the inlet temperature (**Initial temperature**) and any desired ramps.
- 3 Set other parameters as described for a defined column.
- 4 Set **Total flow** into the inlet. Measure flows out of the split vent and septum purge vent using a flow meter.
- 5 Subtract the septum purge flow and split vent flow from **Total flow** to get column flow.
- 6 Calculate the split ratio (split vent flow/column flow). Adjust as needed

MMI splitless and pulsed splitless modes

In these modes—with or without a pressure pulse—the split vent valve is closed during injection and vaporization of the sample and stays so while the sample transfers to the column.

At a specified time after injection, the valve opens to sweep vapors left in the liner out the split vent. This avoids solvent tailing due to the large inlet volume and small column flow rate.

Stage 1. Sample injection

With the split vent valve closed, the sample and solvent transfer to the column.

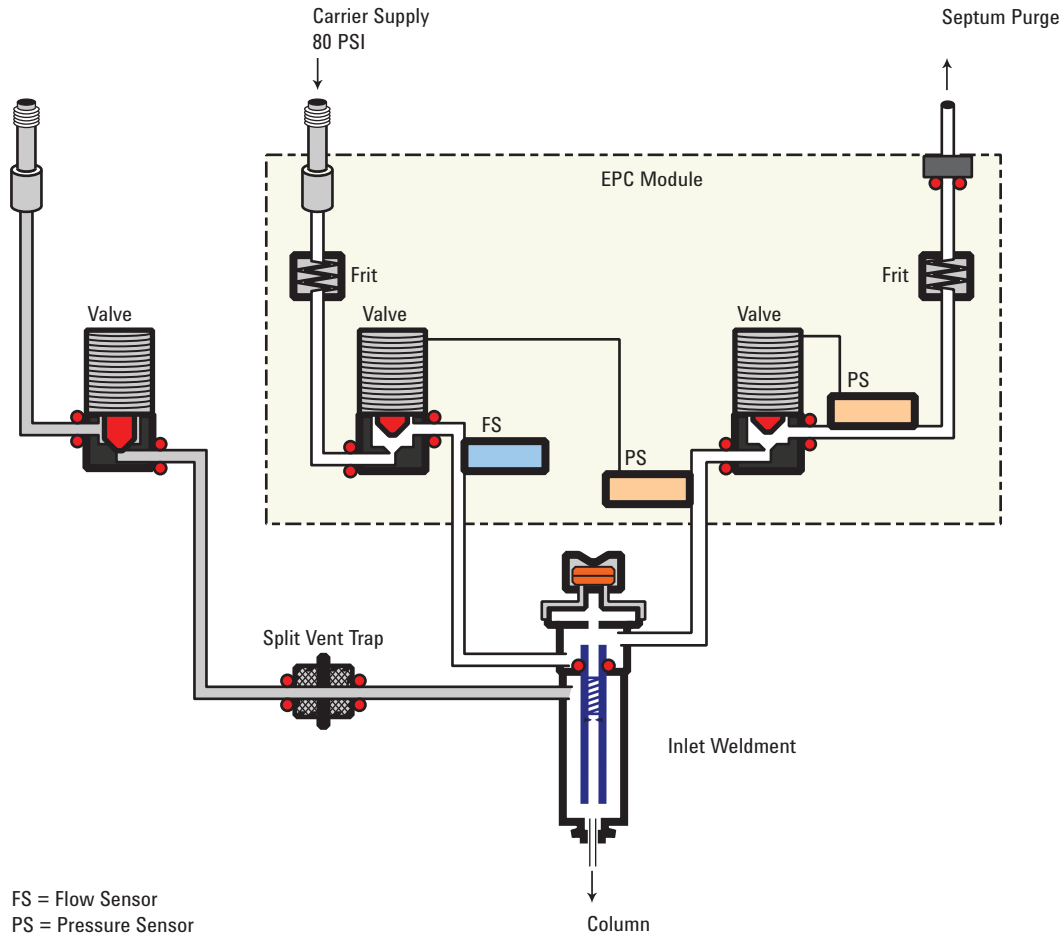

Stage 2. Solvent purging

After the sample has transferred to the column, the split vent valve opens to purge remaining solvent vapor from the inlet.

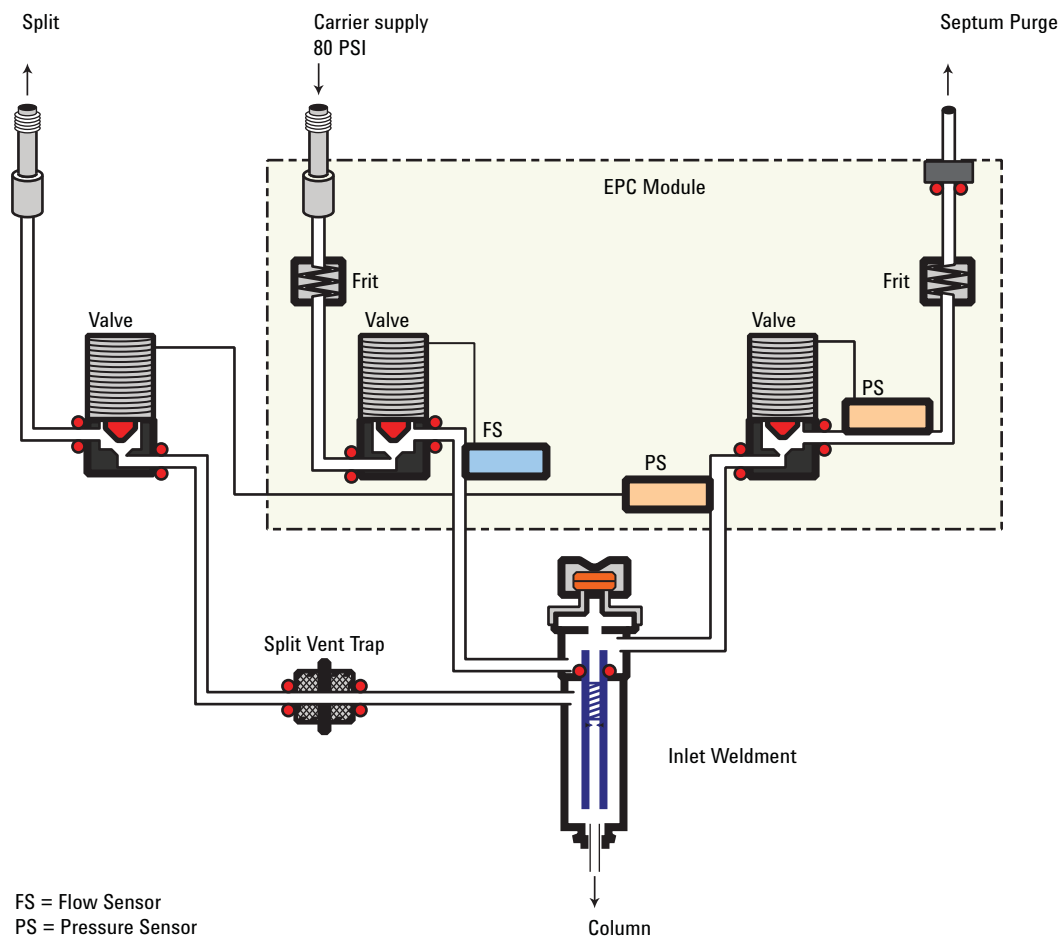

Timelines

This figure summarizes the flow, pressure, and temperature changes during a splitless mode analysis.

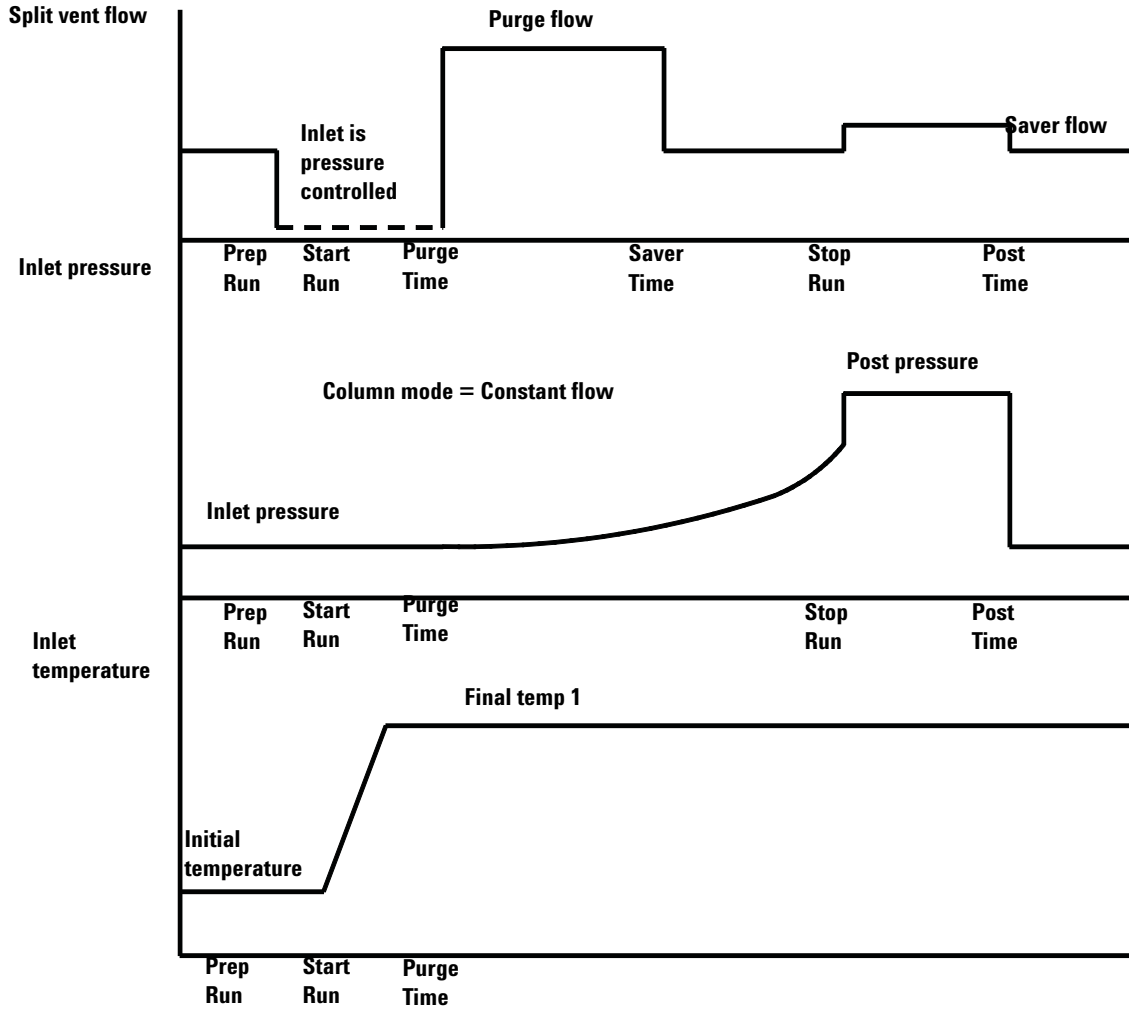

Cold splitless introduction

For cold splitless introduction, use an initial inlet temperature below the normal boiling point of the solvent. For most solvents, starting the first inlet temperature ramp at 0.1 minutes provides good transfer and reproducibility. A program rate of 500 °C/min or higher is appropriate for thermally stable analytes. A final temperature of 350 °C, held for 5 minutes, has quantitatively transferred up to C₄₄ alkane.

A main advantage of temperature programmability is that the inlet can be heated gently to transfer delicate analytes. If the oven temperature is initially low enough to refocus the analytes on the column, the inlet heating rate can be made slower (e.g., 120 °C/min). This reduces thermal degradation from the inlet and can improve peak shape and quantitation.

For most applications of cold splitless, a single temperature ramp is enough. The remaining ramps can be used to clean the liner or to decrease the inlet temperature to prepare for the next injection.

Hot splitless introduction

For hot splitless introduction, select an initial temperature high enough to volatilize the analytes. No additional temperature parameters are required as the inlet will maintain the setpoint throughout the run.

Starting values

A successful splitless injection consists of these steps:

- 1 Inject the sample and temperature program the inlet to vaporize it.
- 2 Use a low column flow and low oven temperature to create a solvent-saturated zone at the head of the column.
- 3 Use this zone to trap and reconcentrate the sample at the head of the column.
- 4 Wait until all, or at least most, of the sample has transferred to the column. Then discard the remaining vapor in the inlet—which is mostly solvent—by opening a purge valve. This eliminates the long solvent tail that this vapor would otherwise cause.
- 5 Raise the oven temperature to analyze the sample.

Some experimentation is needed to refine the operating conditions. Table 12 provides starting values for the critical parameters.

Table 12 Splitless mode inlet parameters

Parameter	Allowed setpoint range	Suggested starting value
Oven temperature	No cryo, ambient+4 °C to 450 °C CO ₂ cryo, -40 °C to 450 °C N ₂ cryo, -80 °C to 450 °C	10 °C below solvent boiling point
Oven initial time	0 to 999.9 minutes	≥ Inlet purge time
Inlet purge time	0 to 200.0 minutes	$\frac{2 \times \text{Liner volume}}{\text{Column flow}}$
Gas saver time	0 to 999.9 minutes	After purge time
Gas saver flow	15 to 200 mL/min	15 mL/min greater than maximum column flow
Inlet temperature	No cryo, oven temp + 10 °C CO ₂ cryo, -70 °C to 450 °C N ₂ cryo, -160 °C to 450 °C	10 °C below solvent boiling point for 0.1min, then ramp up

Setting parameters for the splitless modes

Mode: The current operating mode—Splitless or Pulsed splitless.

Temperature Actual and setpoint inlet temperatures.

Initial time Hold time at the initial inlet temperature.

Rate # Temperature program rates for inlet thermal ramps.

Final temp # Final inlet temperature for ramp 1-10.

Final time # Hold time at Final temp 1-10.

Pressure Actual and setpoint inlet pressure in psi, bar, or kPa

Pulsed pres The inlet pressure you desire at the beginning of a run. The pressure rises to this setpoint after [Prep Run] is pressed and remains constant until **Pulse time** elapses, when it returns to **Pressure**.

Pulse time Pressure returns to its normal setpoint at this time.

Purge time The time, after the beginning of the run, when you want the split vent valve to open.

Purge flow The flow, in mL/min, from the split vent, at **Purge time**. You will not be able to specify this value if operating with your *column not defined*.

Total flow The Total flow line displays the actual flow to the inlet during a Pre-run (Pre-run light is on and *not* blinking) and during a run before purge time. You cannot enter a setpoint at these times. At all other times, Total flow will have both setpoint and actual values.

Septum purge Flow through the septum purge vent

Gas saver On to reduce split vent flow at **Saver time**

Server flow Reduced split vent flow, at least 15 mL/min

Server time Time when flow is reduced to save gas

If the column is defined

- 1 Press **[Front Inlet]**.
- 2 Scroll to **Mode:** and press **[Mode/Type]**. Select **Splitless** or **Pulsed splitless**.
- 3 Set the inlet temperature and any desired ramps.
- 4 Enter a **Purge time** and a **Purge flow**.
- 5 If desired, turn **Gas saver** on. Make certain the time is set after the **Purge time**.
- 6 Press **[Prep Run]** (see “Pre Run and Prep Run” on page 40) before manually injecting a sample. This is automatic if an Agilent sampler is used.

If the column is not defined

- 1 Press **[Front Inlet]**.
- 2 Scroll to **Mode:** and press **[Mode/Type]**. Select **Splitless** or **Pulsed splitless**.
- 3 Set the inlet temperature and any desired ramps.
- 4 Enter a **Purge flow**.

- 5 Enter the **Purge time** when you wish the split valve to open.
- 6 Set **Total flow** greater than the column flow plus the septum purge flow to guarantee adequate column flow.
- 7 Turn **Gas saver** on, if desired. Set the time after **Purge time**.
- 8 Press [**Prep Run**] (see “[Pre Run and Prep Run](#)” on page 40) before manually injecting a sample. This is automatic if an Agilent sampler is used.

MMI solvent vent mode

This mode is typically used for large volume injections. For single injection use a 50 to 500 μL syringe and the ALS variable plunger speed to slowly inject the sample.

The sample is injected into a cold inlet. If conditions are properly chosen and the sample is suitable, analytes deposit in the inlet liner while the solvent evaporates and is swept out. Large or multiple injections can be used to concentrate sample in the inlet before transferring to the column for analysis.

Stage 1. Sample and vent

During sampling and venting, the split valve is open. The inlet is at **Initial temperature**, which is at or below the solvent boiling point.

Solvent vapors are swept out the vent, while sample deposits on the liner walls or packing.

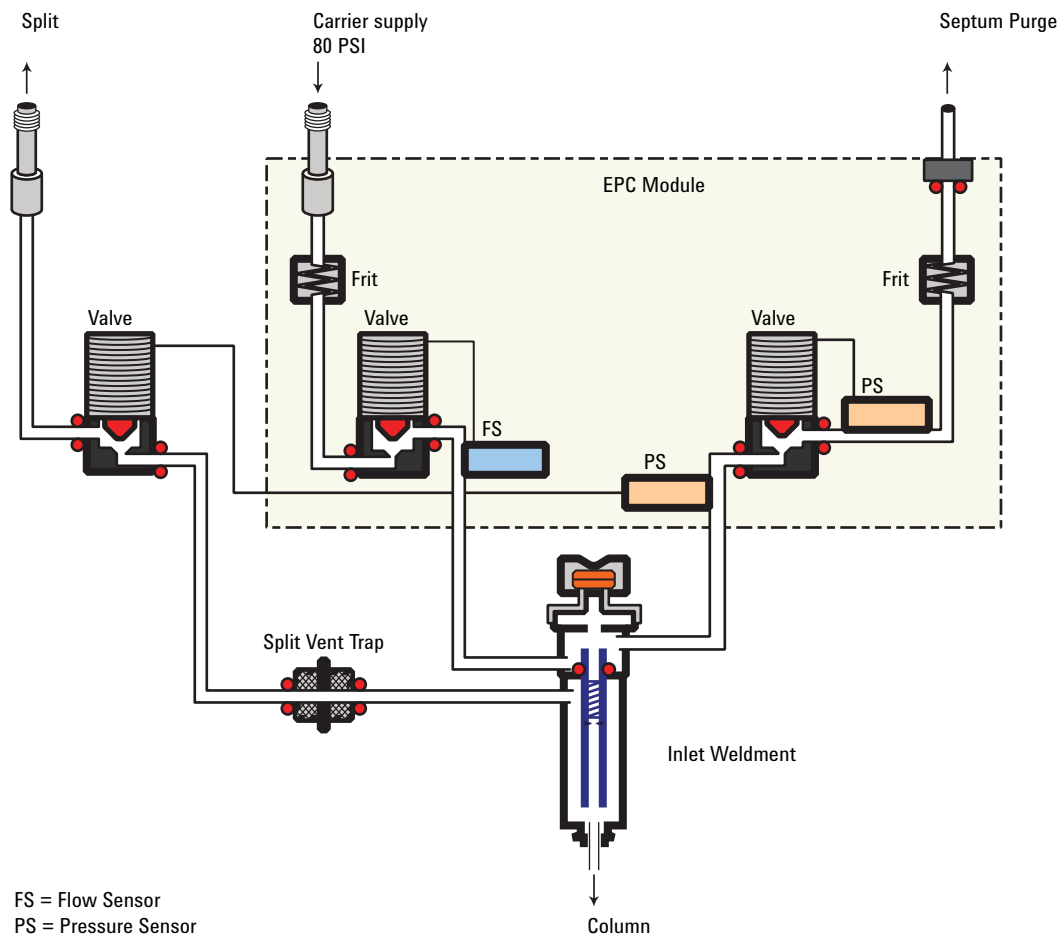

Stage 2. Sample transfer

When solvent venting ends, the split valve vent closes and the inlet heats to **Final temperature 1**. The sample transfers to the capillary column during **Purge time**. (**Purge flow to split vent** in a data system).

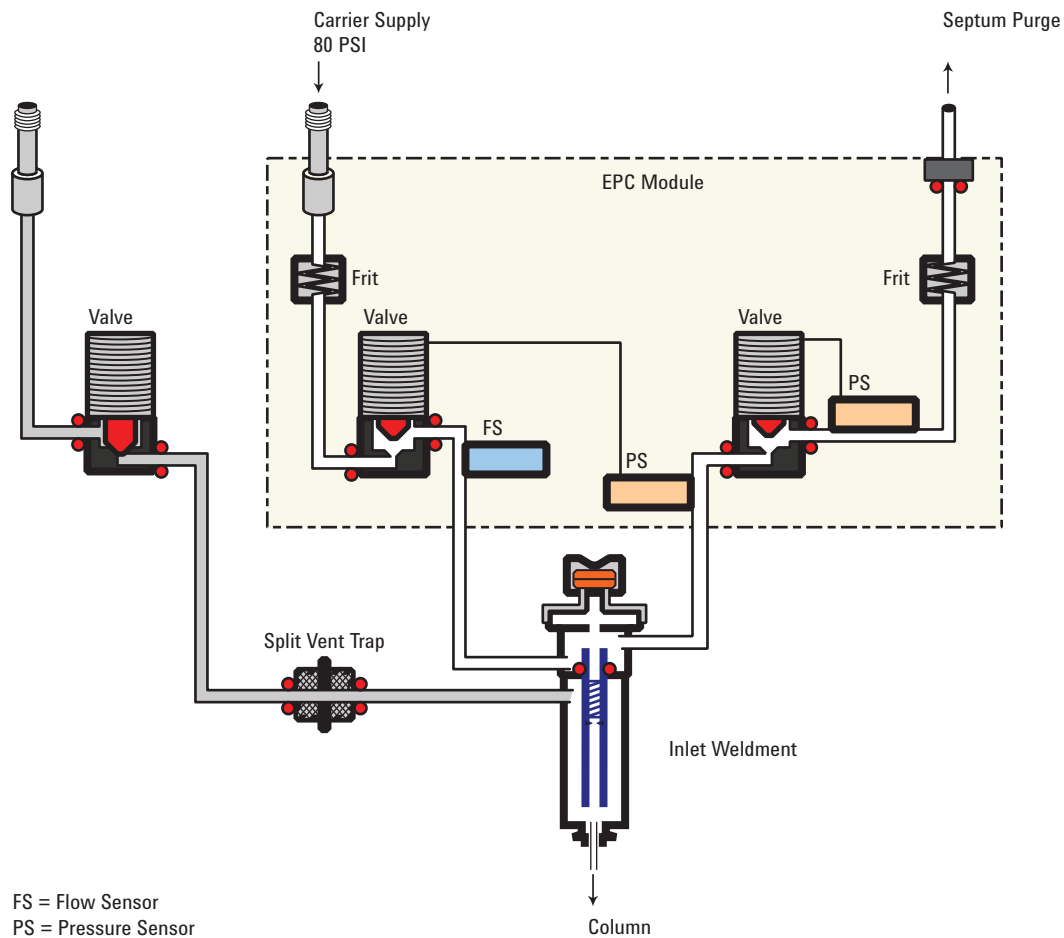

Stage 3. Purge and cleanup

The split valve opens again and the system returns to the Stage 1 configuration but with different setpoints. The MMI is flushed. Additional ramp rates are available to thermally clean the inlet or to reduce inlet temperature after sample transfer. This can extend the life of the liner.

Temperature, pressure, and flow considerations

The solvent vent mode goes through three distinct pneumatic states; venting, sample transfer, and purging. The vent portion allows the inlet pressure and the vent flow to be adjusted to optimize solvent elimination. The transfer state

mimics traditional splitless operation and transports the analytes from the liner to the column. The purging mode allows the user to prepare the inlet for the next run.

A fundamental difficulty with solvent vent mode is the potential loss of volatile analytes with the solvent. Several solutions are possible for this situation:

- The inlet liner can be packed with a more retentive material, such as Tenax. This greatly improves volatile analyte recovery but may impact recovery of higher boiling materials.
- Some of the solvent can be left in the liner when sample transfer begins. The residual solvent acts like a stationary phase and retains volatile material, but at the expense of a larger solvent peak.
- The inlet temperature can be reduced. This reduces the vapor pressure of the volatile analytes and permits higher recoveries.

Solvent removal can be speeded up by:

- Reducing pressure in the inlet during sample introduction—the **Vent pressure** parameter
- Increasing flow through the inlet—the **Vent flow** parameter

While all these possibilities do complicate use of the PTV, they provide increased flexibility and new potential to solve difficult problems.

Sequence of operations

These are the steps in a typical analysis using the solvent vent mode:

Table 13 The solvent vent process

Step	Parameter	Value
1	Before injection	Flow at split vent
		Inlet pressure
The system is resting, with Purge flow (or Saver flow, if on) through the inlet.		
2	Prep Run begins	Flow at split vent
		Inlet pressure
Setpoints change to prepare for injection. When GC is ready, the sample is injected. Inlet and oven temperature program Init times begin. Solvent venting and analyte trapping begin.		
3	At Vent end time	Flow at split vent
		None, split valve closed

Table 13 The solvent vent process (continued)

Step	Parameter	Value
	Inlet pressure	Column pressure setpoint
Solvent venting ends, analyte transfer begins as inlet heats up.		
4	At Purge time	Flow at split vent
		Purge flow setpoint
	Inlet pressure	Column pressure setpoint
Analyte transfer ends, inlet is purged of residual vapor. Analysis begins.		
5	At Saver time	Flow at split vent
		Saver flow setpoint
	Inlet pressure	Column pressure setpoint
Analysis ends, carrier flow reduced to save gas (if Saver is on).		

Some important points

- The flow through the column is governed by the pressure in the inlet. This is controlled, during the analysis part of the process, by the flow or pressure setpoint or program entered *for the column*.
- The controlling times must be in the order shown; Vent end time *before* Purge time, and Purge time *before* Saver time.
- Vent end time must occur before the inlet starts to heat and release analytes.
- Purge time must occur before the oven begins to heat and move sample through the column.

Timelines

Time increases downward; all other quantities increase to the right.

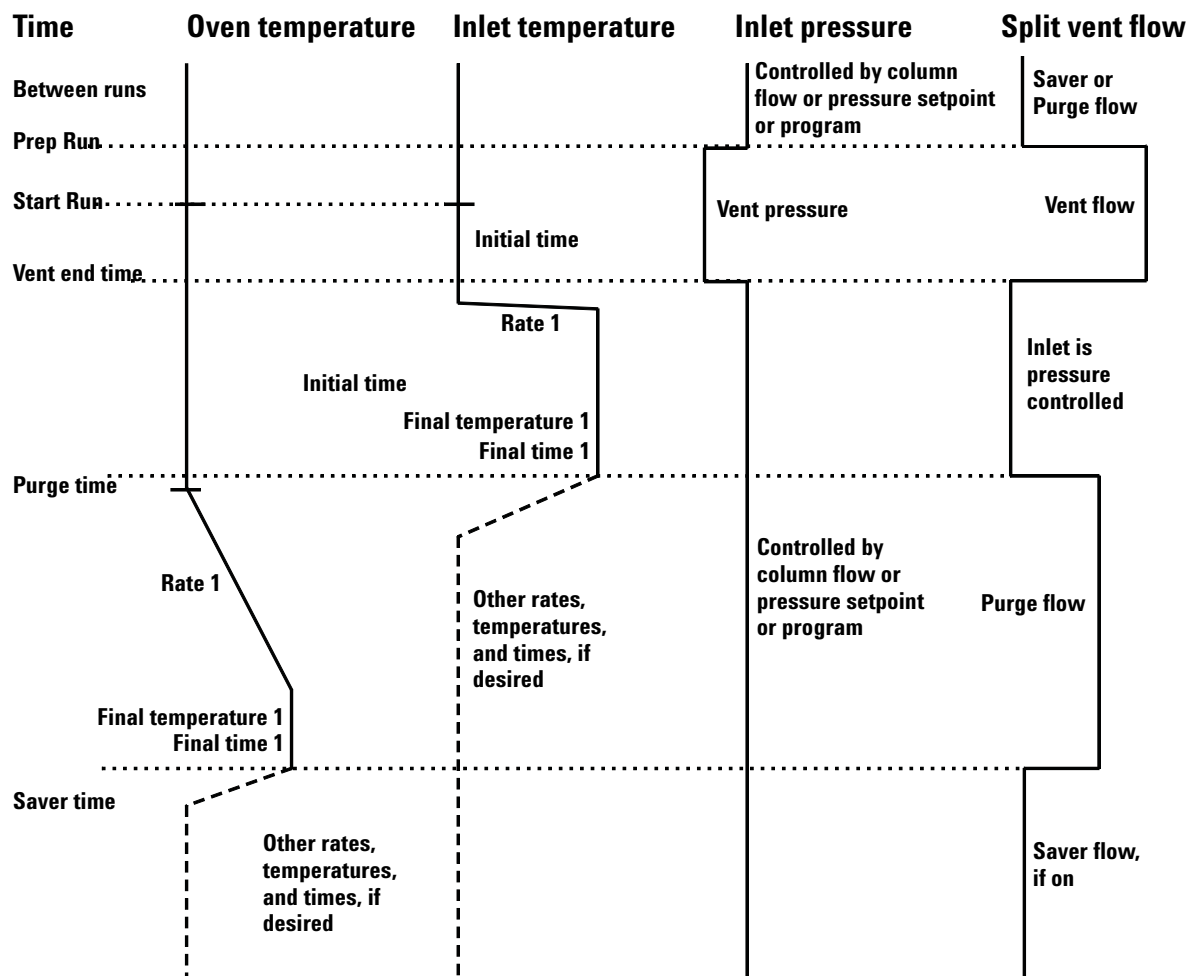

When is Start Run?

Both the inlet and oven temperature programs begin at Start Run. All times—such as Purge time—are measured from Start Run. When does Start Run occur?

- If the sample is injected manually, Start Run occurs when the user presses the **[Start]** key.
- If a single injection per run is made using an autosampler, Start Run occurs when the syringe carrier moves down to make the injection.
- If multiple injections per run are made using an autosampler, Start Run occurs when the syringe carrier moves down to make the first injection of the set. There are no Start Run signals for the rest of the injections in the set.

These additional injections take time. The inlet and oven temperature programs, mainly the **Initial time** values, must be adjusted to allow for this. So must the various time values that control the inlet operation. This is discussed in more detail under “[To develop a MMI method that uses large volume injection](#)” on page 77.

Setting parameters for solvent vent operation

Mode: The current operating mode—solvent vent.

Temperature Actual and setpoint initial inlet temperatures.

Initial time The time, measured from Start Run, when the initial inlet temperature hold ends. Must be greater than **Vent end time**.

Rate # Temperature program rate for inlet thermal ramps.

Final temperature # Final inlet temperature for ramp 1-10.

Final time # Hold time at **Final temp #**. This time is a duration; it is *not* measured from Start Run.

Pressure Actual and setpoint inlet pressure before and after the vent period. It sets the starting point of column head pressure.

Vent pressure The inlet pressure during the vent period. By decreasing the inlet pressure while venting, solvent elimination proceeds faster. Also, the pressure reduction decreases the amount of carrier gas—and solvent vapor—that enters the column during this time.

Users select from 0 to 100 psig. If 0 is chosen, the inlet uses the lowest pressure possible at the given vent flow. [Table 14](#) shows approximate values for this minimum at various vent flows of helium. Pressures less than those in the table are not possible unless the flow is reduced.

Table 14 Minimum attainable pressures

Vent flow (mL/min)	Actual vent pressure at "0" psig setpoint	Actual vent pressure at "0" kPa setpoint
50	0.7	5
100	1.3	10
200	2.6	18
500	6.4	44
1000	12.7	88

Vent flow The flow of carrier gas out the split vent during the vent period. Higher flows sweep the liner more quickly and reduce the time for solvent elimination. For most columns, 100 mL/min vent flow eliminates solvent at an acceptable rate but puts minimal material on the column.

Vent end time The time, measured from Start Run, when solvent venting ends. For large volume injections, this time is normally greater than the time for the injection to complete.

Purge time The time, measured from Start Run, when sample transfer ends. It began at **Vent end time**.

Purge flow The flow of carrier gas to the inlet beginning at **Purge time**.

Total flow The actual flow into the inlet.

Septum Purge Flow through the septum purge vent

Gas saver On to reduce split vent flow at **Saver time**

Saver flow Reduced split vent flow, at least 15 mL/min

Saver time Time when flow is reduced to save gas

If the column is defined

- 1 Press [**Front Inlet**].
- 2 Scroll to **Mode:** and press [**Mode/Type**]. Select **Solvent vent**.
- 3 Enter a **Vent pressure**, a **Vent flow**, and a **Vent end time**.
- 4 Set the inlet temperature and ramps, as desired.
- 5 Enter a **Purge time** and a **Purge flow**.

- 6 If desired, turn **Gas saver** on. Make certain the time is set after the **Purge time**.
- 7 Press [**Prep Run**] (see “**Pre Run and Prep Run**” on page 40) before manually injecting a sample.

If the column is not defined

- 1 Set up the parameters as described for the defined column case.
- 2 Set **Total flow** greater than the column flow plus the septum purge flow to guarantee adequate column flow.

MMI Direct Mode

MMI Direct Mode is a pneumatic configuration that allows on-column like behavior. In this mode, you still use a liner to trap involatile material but the sample can only enter the column.

Direct mode works best with direct connect liners. These liners form a seal with the column so that the sample cannot leak out of the liner. The inlet is held at a temperature below the solvent boiling point, just as in cool on-column (COC) during the injection. Pneumatically, the inlet is in forward pressure regulation, similar to the splitless portion of splitless mode. The inlet is then temperature programmed to transfer any remaining volatile material to the column.

The only control parameter for Direct Mode is inlet pressure. You can run the column in any of its normal control modes (constant pressure, constant flow, ramped pressure, ramped flow). Gas saver does not work in this mode as there is no purge state.

The next figure shows the flows with direct mode.

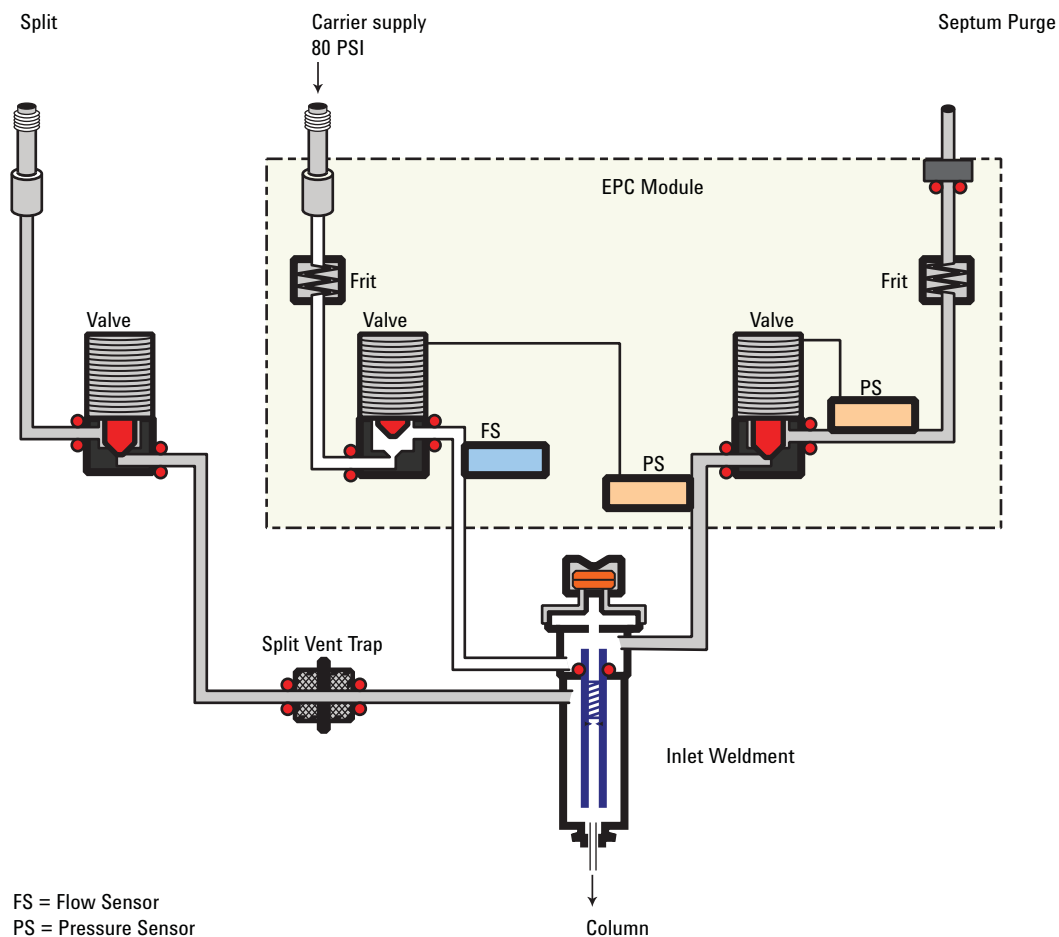

To develop a MMI method that uses large volume injection

This topic provides a recommended way to change from a splitless injection using a split/splitless inlet to a solvent vent mode injection using a Multimode inlet (MMI). It applies mainly to large volume injections (LVI) using a Multimode inlet, but the concepts can apply to general MMI use. This topic does not consider all items that can impact an analysis, for example the liner, solvent, analyte boiling points, or polarity. This topic also assumes knowledge of your data system—when to save a method, how to start a run, how to set up a single run, etc.

The main advantage of the MMI's solvent vent mode is that you can inject slowly into the inlet, allowing large amounts of solvent to evaporate in the liner (not in the split vent line), concentrating the analytes prior to injection. This requires an injector with variable speed injections, a "large" syringe, and knowledge of the sample and the solvent. When developing a solvent vent method, the goal for the injection is to determine the injection rates and temperatures needed to evaporate the solvent at the rate it enters the inlet. The development technique is to gradually scale up to an injection amount that produces a useful response. The most significant parameters are:

Inlet temperature. Hold the inlet temperature at or slightly below the solvent boiling point until after all the sample has been injected. This is important so that you do not boil away more volatile analytes, or boil away the solvent in the needle and trap your analytes there. An additional point to consider is that the boiling point of the earliest eluting analyte should be $100\text{ }^{\circ}\text{C} >$ the boiling point of the solvent.

Injection speed. Estimate the evaporation rate of solvent exiting the needle based on solvent type, inlet temperature, vent flow, and pressure. Start with about half that number. Note that you have to make sure that you configure the syringe properly. If not, you will over- or under-load the inlet.

Vent time. Make sure the vent time setpoint is greater than the time the needle spends in the inlet. If the vent time is too short, you will overload and contaminate the column and inlet. Change the vent time as you upscale the method.

If using a MMI with an MS, another tip for method development is to scan for solvent ions. Detecting the solvent ions can be useful in troubleshooting residual solvent bleed onto the column.

To develop a MMI method for large volume injection, try the following:

- 1 Determine a small injection volume that works on a split/splitless inlet in splitless mode. Choose a volume that does not currently overload the inlet.
- 2 Start with a 5–10 uL syringe and make sure the syringe is properly configured in the instrument and data system.
- 3 Make sure the column is configured.

- 4 Set up the inlet to perform a 1 uL injection. Use the split/splitless inlet method conditions, except:
 - Start with the inlet temperature cold, near but slightly below the solvent boiling point. For example, if using methylene chloride (boiling point 39 °C), start with a temperature of 30–39 °C.
 - Use Splitless mode.
 - Ramp to the normal split/splitless inlet temperature
- 5 Note the response achieved.
- 6 Next, change the inlet mode to Solvent Vent.
- 7 Check the injector timings.
 - a Install an empty sample vial in the injector turret or tray.
 - b Input the injection rate (Draw, Dispense, and Inject rates) for the injector and increase the injection volume to 5 uL.
 - c Enter draft Solvent Vent parameters:
 - Set a Vent Flow of 100 mL/min as a starting point.
 - Keep the inlet isothermal for now
 - Enter a Vent Pressure of 0 psi (0 kPa) until 0.1 min.
 - Make an injection using the empty vial. Use a stopwatch or your GC's timer feature to time how long the needle is in the inlet.
- 8 Enter revised Solvent Vent mode parameters.
 - Set the method's Vent Time to be about 0.05 min longer than the time the needle spends in the inlet.
 - Set the inlet temperature initial Hold Time to be about 0.05 min longer than the vent pressure until time.
 - Program the inlet to ramp quickly to the injection temperature. Make sure the ramp starts after the vent pressure until time.
 - Set the Purge Flow to Split Vent to 30 mL/min. Set the purge time to be the vent pressure until time + 1 minute.
- 9 Make a 5 uL injection of your standard. You should see 5 times the response.

If the response of all analytes is too low:

- The dispense speed is too fast. Liquid was injected into the inlet and pushed out the vent.

- The vent time is too long. The inlet started to heat while the vent was open.

If the response of early eluters is too low:

- The inlet temperature is too high.
- The Vent Flow is too high.

If the response of late eluters is too low:

- The purge time is too short.
- The final inlet temperature is too low.

- 10** If you need more injection volume and the 5 uL worked to give 5X response, change the syringe to a larger one, for example 50 uL.
- 11** Set up the data system to perform a 25 uL injection.
- 12** Configure the syringe. Make sure the plunger speeds on the injector are still set properly.
- 13** Recheck the injector timings. See [step 12](#).
- 14** Set a new vent time and initial inlet temperature time based on the new time the needle spends in the syringe.
- 15** Make a 25 uL injection of your standard. Again, you should see 5 times the response. If not, see [step 13](#).
- 16** If you need more response, repeat steps 10 – 15 to increase to larger volume. Also try performing 5 x 5 uL injections, then 5 x 50 uL injections.

Multiple injections with the MMI

The preferred technique for concentrating analytes in the inlet liner is to use a single, large volume injection. Using a high capacity syringe and one septum puncture reduces the possibility of contamination and generally improves results when compared against a multiple septum puncture technique. However, if needed, you can perform multiple septum punctures during the vent time. This technique requires an Agilent data system and automatic liquid sampler.

Data system requirements

An Agilent data system is necessary for multiple injection because the needed parameters are not available through the GC keyboard.

OpenLAB CDS All

MassHunter Workstation All

GC ChemStation Software revision B.04.01 SP1 or later

MSD ChemStation Software revision E.02.00 SP2 or later

EZChrom Software revision 3.3.2 or later

Setting parameters for the inlet in solvent vent mode

Set or configure the following parameters in the data system's 7890 Series GC method editor.

Syringe size – Verify the syringe size is configured correctly. The configured syringe size changes the available choices for injection volume.

Injection volume – Select the injection volume, then enter a number of injections. The total injection volume will be displayed.

Multiple Injection Delay – A pause time, in seconds, between injections. This is added to the minimum hardware cycle time.

Preinjection washes and pumps are performed only before the first injection of a multiple injection set.

Postinjection washes are performed only after the last injection in a multiple injection set.

An example

These values were used for a sample with a broad range of boiling points.

Table 15 General parameters

Name	Value
Sample	C ₁₀ to C ₄₄ hydrocarbons in hexane
Mode	Solvent vent
MMI liner	Glass wool packed
Injection volume	One 10.0 µL injection (25 µL syringe)
Injection speed	Fast
Column	30 m x 320 µm x 0.25 µm -5, part number 19091J-413
Column flow	4 mL/min constant flow

Table 16 Inlet parameters

Name	Value	Name	Value
Initial temp	40 °C	Rate 2 (off)	
Initial time	0.3 min	Pressure	15.6 psig
Rate 1	720 °C/min	Vent pressure	0.0 psig
Final temp 1	450 °C	Vent flow	100 mL/min
Final time 1	5 min	Vent end time	0.2 min
Rate 2	100 °C/min	Purge time	2.0 min
Final temp 2	250 °C	Purge flow	50 mL/min
Final time 2	0 min		

Table 17 Oven parameters

Name	Value
Initial temp	40 °C
Initial time	2.5 min
Rate 1	25 °C/min
Final temp 1	320 °C
Final time 1	10.0 min
Rate 2 (off)	

Table 18 Detector parameters

Name	Value
Detector	FID
Detector temp	400 °C
Hydrogen flow	40 mL/min
Air flow	450 mL/min
Makeup (N ₂)	45 mL/min

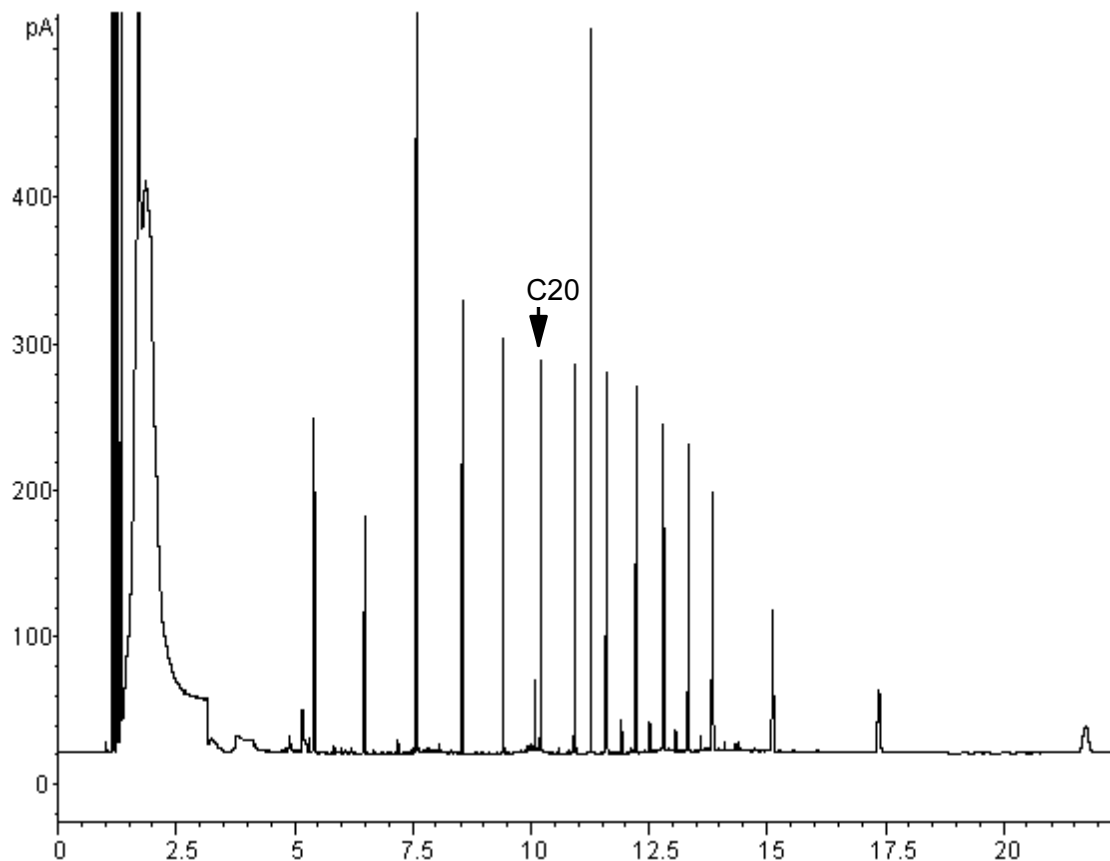

These results were compared with a splitless analysis of the same sample, which should produce 100% recovery of all analytes. The data showed that, under these conditions, compounds above C_{20} were completely recovered and that the recovery was independent of injection size. Compounds lower than C_{20} were partially vented with the solvent.

Possible adjustments

Depending on what you are trying to accomplish, you have a number of possible adjustments available.

To eliminate more solvent

- Increase the vent end time, inlet initial time, and purge time. This will not affect analytes that are quantitatively trapped but will eliminate more of the solvent peak.
- Increase the vent flow to sweep the liner more rapidly with the same inlet timing. Increasing vent flow raises vent pressure if it is set to 0. This puts more solvent onto the column.

- Raise the inlet initial temperature to vaporize more solvent and allow more to be eliminated. This also increases the loss of volatile analytes since their vapor pressures also increase.

To improve recovery of low boiling analytes

- Reduce inlet temperature to lower the vapor pressure of the analytes and trap them more effectively. This also reduces solvent vapor pressure and more time will be needed to eliminate it.
- Use a retentive packing in the liner. Materials such as Tenax permit higher recovery of volatile analytes but may not release higher boiling compounds. This must be considered if quantitation on these high boiling peaks is desired.
- Leave more solvent in the liner. The solvent acts as a pseudo stationary phase and helps retain volatile analytes. This must be balanced against the detector's tolerance for solvent.

An example—continued

The single injection example shown on the last few pages makes it clear that a 10 μL injection does not overload the glass wool packed liner. This means that multiple 10 μL injections are possible.

It was decided to make 10 injections per run, each of 10 μL size. This would increase analytical sensitivity substantially. No adjustments were made to improve recovery of the low boilers since the purpose of this analysis was to detect and measure the high boiling components.

After timing a trial set of 10 injections, the total time for the multiple injection set was measured to be approximately 1.3 minutes. The following timing changes were made:

Table 19 Modifications

Parameter	Increased from	To
Inlet Init time	0.3 minutes	1.6 minutes
Vent end time	0.2 minutes	1.5 minutes
Purge time	2.0 minutes	3.0 minutes
Oven Init time	2.5 minutes	3.0 minutes

The result is shown in the next figure. Note the difference in the vertical scale (5000 versus 500).

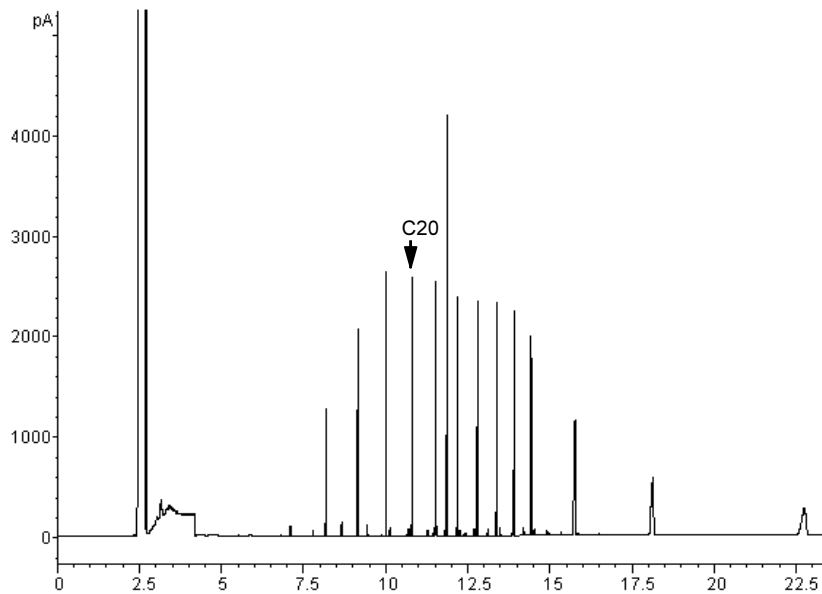

About the Packed Column Inlet

This inlet is also known as the purged packed inlet (PP). It is used with packed columns when high-efficiency separations are not required. It can also be used with wide-bore capillary columns, if flows greater than 10 mL/min are acceptable.

If the columns are not defined (packed columns and undefined capillary columns), the inlet is usually flow-controlled. If capillary columns are used and the columns in the flow path are defined, the inlet is normally pressure-controlled but can be put into the flow control mode.

The figure shows the inlet in the capillary column mode, with the column defined and the flow controlled by pressure.

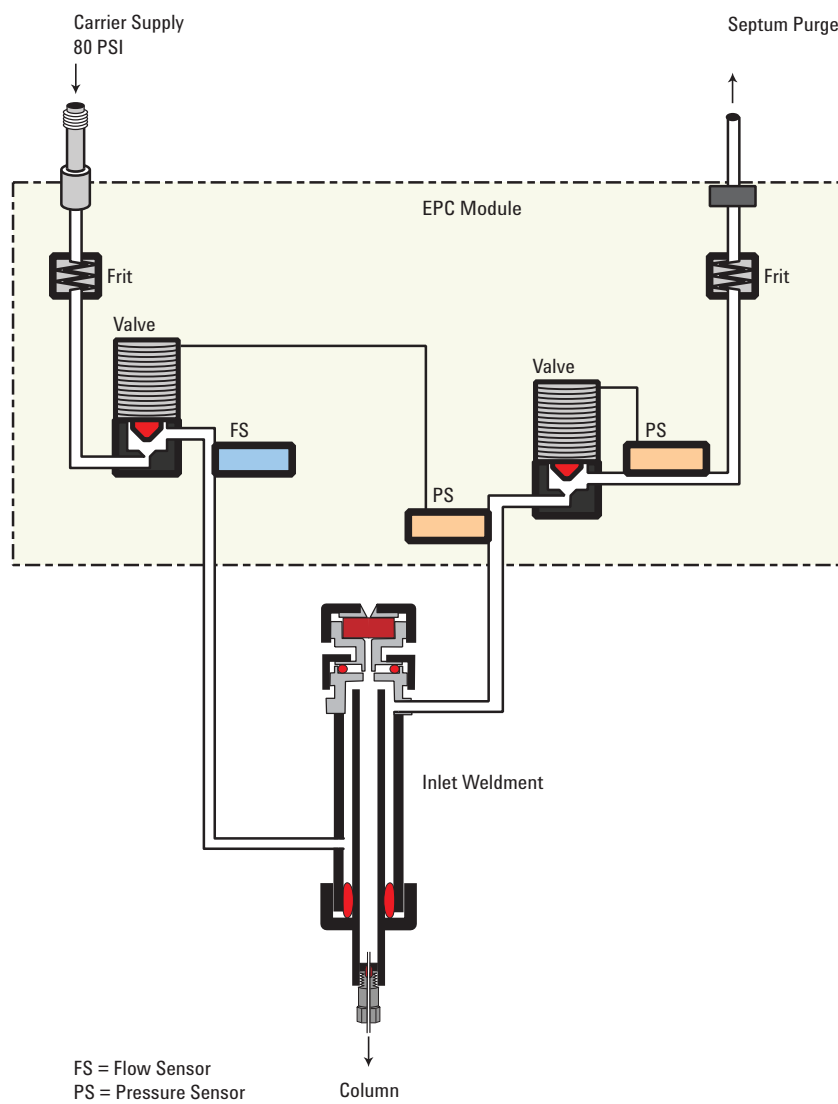

The next figure shows the flow diagram for the packed column mode, with the column not defined the control is based on total carrier gas flow.

3 Inlets

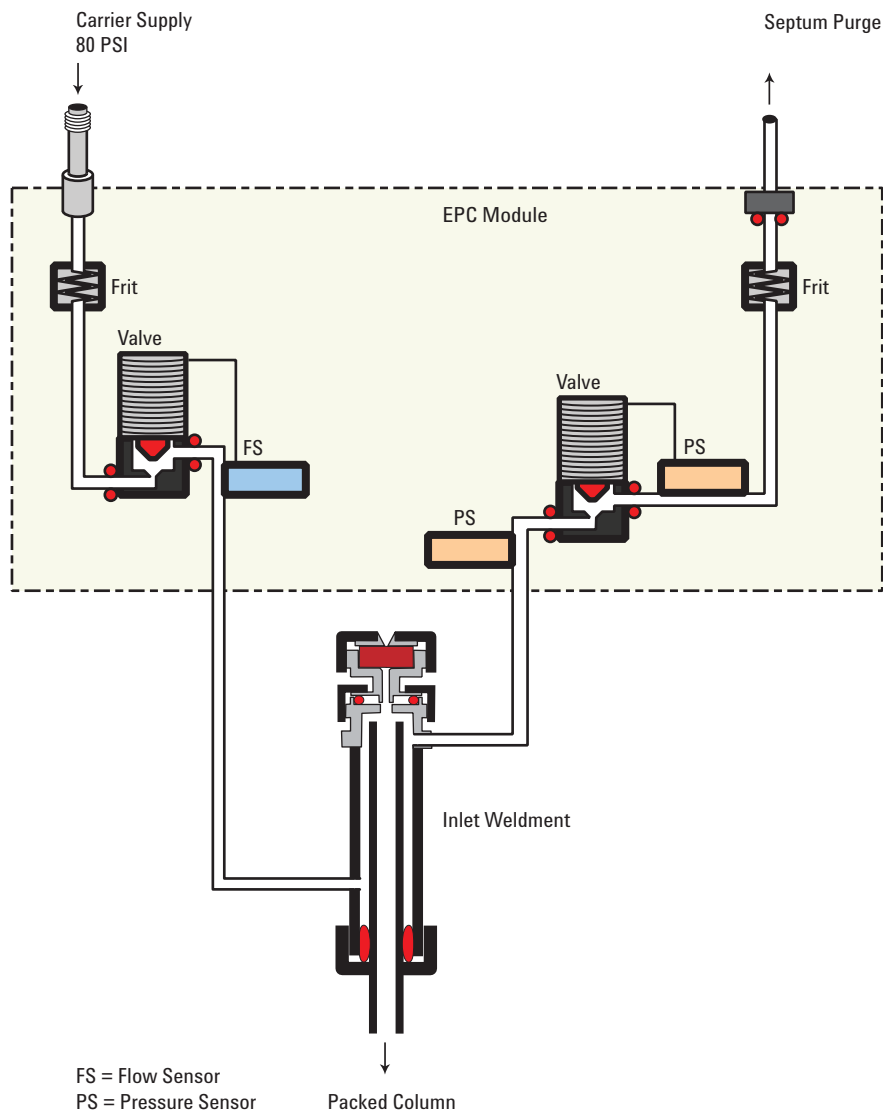

Setting parameters

The inlet can operate in flow or pressure control mode. Flow is recommended for packed columns. Pressure is recommended for capillary columns.

Inlet in flow control mode

While in flow control mode, you cannot enter pressures here.

Mode Press [**Mode/Type**] to see the choices. You may select an inlet mode of either **Pressure control** or **Flow control**. When the Inlet control mode is **Pressure control**, the column control mode can be set to **Constant pressure, Ramped pressure, Constant**

flow, or Ramped flow. The column control mode is set from the Column parameters display. When the Inlet control mode is Flow control, only column flow can be set on the Column parameters display.

Temperature The setpoint and actual temperature values.

Pressure The actual pressure (in psi, bar, or kPa) supplied to the inlet. You cannot enter a setpoint here.

Total flow Enter your setpoint here, actual value is displayed. Inlet is mass flow controlled.

Septum purge The setpoint and actual flow, in mL/min, through the septum purge line, typically 1 to 5 mL/min

Inlet in pressure control mode

While in pressure control mode, you cannot enter flows here.

Mode Press [Mode/Type] to see the choices. You may select an inlet mode of either **Pressure control** or **Flow control**. When the Inlet control mode is **Pressure control**, the column control mode can be set to **Constant pressure, Ramped pressure, Constant flow, or Ramped flow**. The column control mode is set from the Column parameters display. When the Inlet control mode is Flow control, only column flow can be set on the Column parameters display.

Temperature The setpoint and actual temperature values of the inlet.

Pressure Enter your setpoint here (in psi, bar, or kPa). The actual value is displayed.

Total flow The actual total flow to the inlet. This is a reported value, not a setpoint.

Septum purge The setpoint and actual flow, in mL/min, through the septum purge line, typically 1 to 5 mL/min

About the Cool On-Column Inlet

This inlet introduces liquid sample directly onto a capillary column. To do this, both the inlet and the oven must be cool at injection, either at or below the boiling point of the solvent.

Because the sample does not vaporize immediately in the inlet, problems with sample discrimination and sample alteration are minimized. If done properly, cool-on column injection also provides accurate and precise results.

You can operate the inlet in track oven mode, where the inlet temperature follows the column oven, or you can program up to three temperature ramps. A cryogenic cooling option that uses liquid CO₂ or N₂ from the oven cryogenic system can reach sub-ambient temperatures.

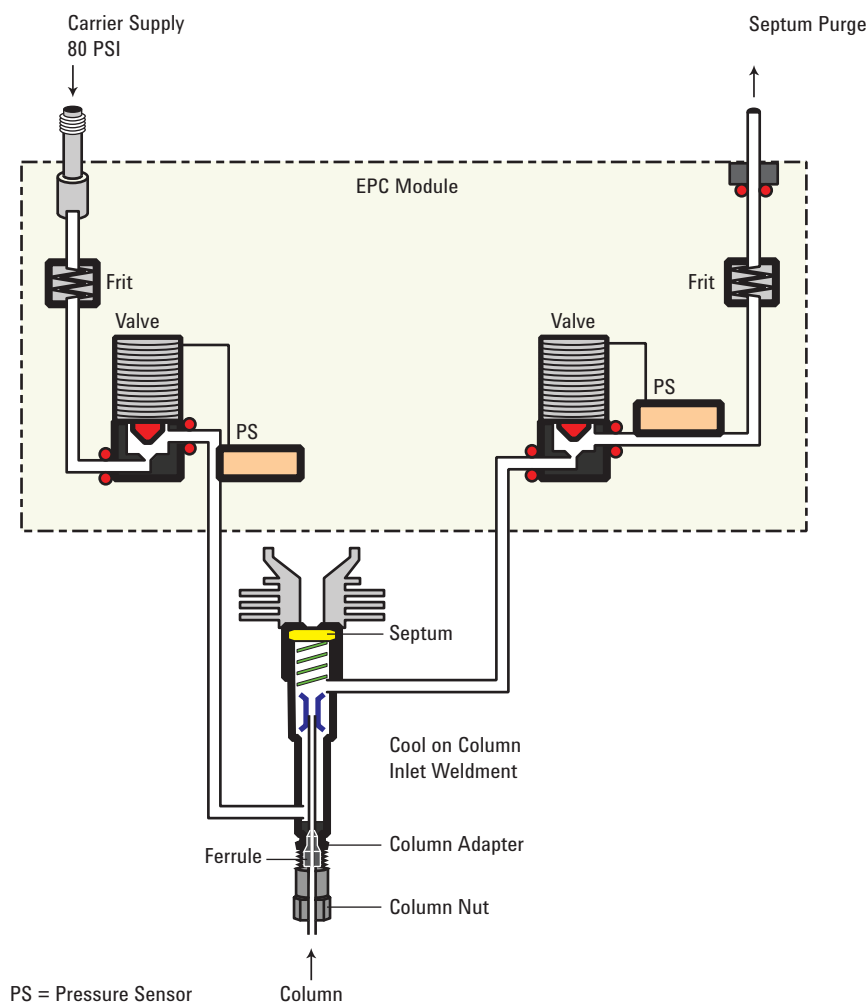

Setup modes of the COC inlet

The COC inlet hardware must be set up for one of three usages, depending on the type of injection and column size.

- 0.25 mm or 0.32 mm automated on-column. Use predrilled septa.
- 0.53 mm automatic on-column or retention gap
- 0.2 mm manual

To select the correct hardware for a column and injection type, refer to [Maintaining Your GC](#).

Retention gaps

Because the sample is injected directly onto the column, it is strongly suggested that a retention gap—or guard column—be used to protect your column. A retention gap is a deactivated column that is connected between the inlet and the analytical column. If you choose to use one, it is suggested that at least 1 m of retention gap be installed per 1 μ L of sample injected. Information on ordering retention gaps can be found in the Agilent catalog for consumables and supplies.

If you are using a retention gap and are operating with the column defined, the length of the retention gap could affect the calculations for flow and velocity through your column. If your retention gap is the same inside diameter as your column, it is a good idea to add the retention gap and column length before entering the number on the Configure Column parameter list. If the retention gap inside diameter is larger than your column, this step may not be necessary.

COC inlet temperature control

CryoBlast (optional)

CryoBlast shortens the cycle time between runs. If you have a CO₂ or N₂ cryogenic valve and the CryoBlast feature, you can cool the inlet to -37 °C in either the track oven or temperature program modes.

The CryoBlast accessory uses coolant from the oven cryogenic system.

Track oven mode

In the **Track oven** mode, the inlet temperature stays 3 °C higher than the oven temperature throughout the oven program. You cannot enter a temperature setpoint—it is set automatically. If you have CryoBlast, the inlet will track oven temperatures to -40°C; without CryoBlast, the lower limit is set by room temperature.

Temperature programming mode

In this mode, you can enter up to three temperature ramps in the inlet parameter list so that the inlet and the oven operate independently. This is the recommended mode if operating below -20 °C.

At these very low oven temperatures, the inlet temperature should be at least 20 °C higher than the oven temperature. This will be more than adequate for solvent focusing.

At temperatures greater than ambient, the inlet should always be at least 3 °C warmer than the oven for proper control of the inlet temperature.

The oven temperature program controls the run. If it is longer than the inlet temperature program, the inlet will remain at its final temperature until the oven program (and the run) ends.

Cryogenic considerations

When using track oven mode with a cryogenic oven, all other inlets must be off or in track oven mode.

If cryo is turned on, and if the inlet is cooled during a run, cryogen is used to achieve the setpoint. This may have a negative impact on the chromatographic performance of the oven and cause distorted peaks.

The inlet uses the same cryo coolant as configured for the oven.

Setting COC inlet flows/pressures

- 1 Configure capillary column to inlet—select constant flow or pressure.
- 2 Set column flow, linear velocity, or inlet pressure.
- 3 Set Septum Purge, typically 3 to 10 mL/min.

Setting COC inlet parameters

Track oven mode

- 1 Press [**Front Inlet**] or [**Back Inlet**].
- 2 Press [**Mode/Type**] and select **Track oven**.

There is no setpoint for **Track oven** mode.

Ramped temperature mode

- 1 Press [**Front Inlet**] or [**Back Inlet**].
- 2 Press [**Mode/Type**] and select **Ramped temp**.
- 3 Enter a value for **Temp**. This is the starting temperature.
- 4 Enter an **Init time**. This is the length of time the inlet will stay at the starting temperature after a run has begun.
- 5 Enter **Rate 1**. This is the rate at which the inlet will be heated or cooled. A Rate of **0** halts further programming.
- 6 Enter **Final temp 1**. This is the inlet temperature at the end of the first ramp.
- 7 Enter **Final time 1**. This is the number of minutes the inlet holds **Final temp 1**.
- 8 To enter a second (or third) ramp, scroll to the appropriate **Rate** line and repeat steps 5 through 7.

About the PTV Inlet

The Agilent Programmed Temperature Vaporization (PTV) Inlet System has five operating modes:

- The *split mode* is generally used for major component analyses.
- The *pulsed split mode* is like the split mode, but with a pressure pulse applied to the inlet during sample introduction to speed the transfer of material to the column.
- The *splitless mode* is used for trace analyses.
- The *pulsed splitless mode* allows for a pressure pulse during sample introduction.
- The *solvent vent mode* is used for large volume injection. Either single or multiple injections can be made for each run.

The PTV inlet can be used with both manual and automatic injection.

For automatic multiple injections (large volume injections), an Agilent data system is required. This function is not available under GC control alone. See [“PTV inlet solvent vent mode”](#) on page 107.

PTV sampling heads

Two heads are available for the PTV inlet.

The septum head uses either a regular septum or a Merlin Microseal™ to seal the syringe passage. A stream of gas sweeps the inner side of the septum and exits through the septum purge vent on the pneumatics module. It may be used with either automatic or manual injection.

The septum head uses either standard 11 mm septa or (with a different cap) a Merlin Microseal.

The septumless head uses a check valve instead of a septum to seal the syringe entrance passage. It may be used with either automatic or manual injection. This head is recommended for subambient inlet operation.

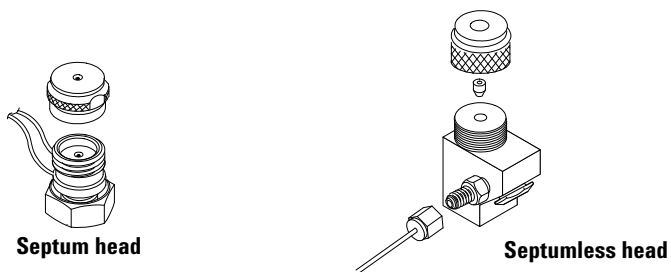

The flow diagrams in the rest of this document show the septum head in place with a separate drawing for the septumless head.

Heating the PTV inlet

The control parameters for PTV temperature programming are the same as for the column oven, but are reached by pressing **[Front Inlet]**. Temperature can be programmed with an initial temperature and up to 3 rates and plateaus. Rates between 0.1 and 720 °C/min can be selected. See [“Setting COC inlet parameters”](#) on page 93 for details.

At the end of the run and during post-run, the PTV is held at its final temperature. This permits backflushing without contaminating the inlet.

CAUTION

If the initial inlet temperature and the oven initial temperature are too close, the inlet may be unable to maintain its setpoint. We recommend a difference of at least 6 °C, either higher or lower.

Additional temperature ramps

For most purposes, the PTV is designed to hold the sample in the inlet liner until the entire sample—there could be several injections—has been injected. Then the PTV is heated rapidly to transfer the sample to the column. This can be accomplished with an initial hold, a single ramp, and a hold at the end to complete sample transfer.

Two additional ramps are available and have several possible uses:

- The inlet can be heated to a high temperature to thermally clean the liner for the next run.

- The inlet can be programmed downward—just set the Final temp below the previous temperature—to reduce thermal stress on the inlet.
- Downward programming can be used to prepare the inlet for the next run. This can reduce cycle time for greater sample throughput.

Cooling the PTV inlet

If cryo is turned on, and if the inlet is cooled during a run, cryogen is used to achieve the setpoint. This may have a negative impact on the chromatographic performance of the oven and cause distorted peaks.

The sample may be injected into either a cooled or heated inlet. The initial inlet temperature can be reduced to $-60\text{ }^{\circ}\text{C}$ (with CO_2 cooling) or to $-160\text{ }^{\circ}\text{C}$ (with liquid N_2 cooling).

The inlet uses the same coolant as configured for the oven.

PTV inlet split and pulsed split modes

The two split modes—with or without a pressure pulse—divide the gas stream entering the inlet between the column flow, the split vent flow through the solenoid valve, and the septum purge flow. The ratio of the split vent flow to the column flow is called the split ratio.

The next figure shows the flows with the septum head. Flows with the septumless head are the same except that the septum purge flow bypasses the head.

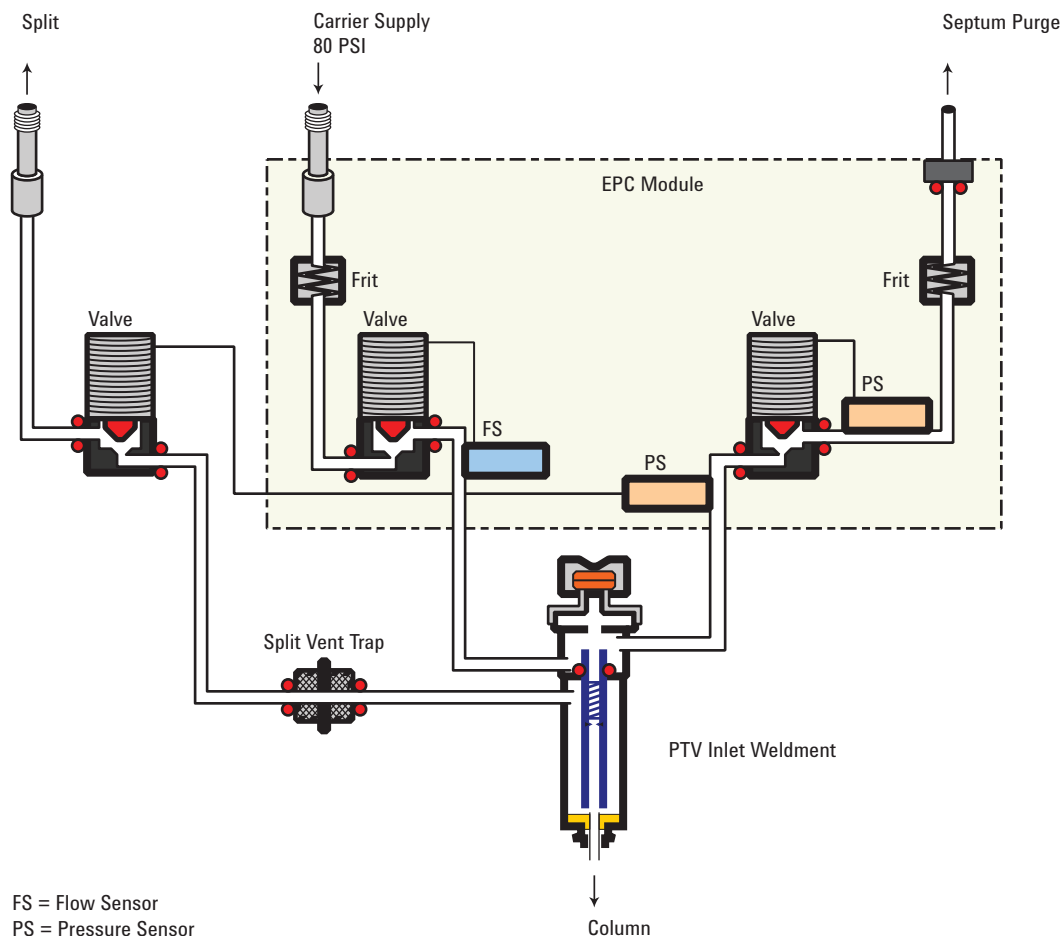

Cold split introduction

For cold split sample introduction, use an initial inlet temperature below the normal boiling point of the solvent. If the liner volume is enough to hold all the vaporized solvent, start the first inlet temperature ramp at 0.1 minutes with a high heating rate (500 °C/min or higher). The final temperature should be high enough to volatilize the heaviest analytes from the liner and should be held for at least 5 minutes. A final temperature of 350 °C for 5 minutes has proven sufficient to quantitatively transfer C₄₄.

For larger injection volumes or to eliminate the solvent, hold the initial temperature long enough to vent the solvent through the split vent and then begin the first ramp. Use a fast rate for thermally stable analytes. Slower rates may help minimize thermal degradation in the inlet.

A single temperature ramp is enough for the injection process. The remaining ramps may be used to clean the liner or to reduce the inlet temperature in preparation for the next injection.

Hot split introduction

For hot split introduction, set an initial temperature high enough to volatilize the analytes. No additional thermal parameters are required as the inlet will maintain the setpoint throughout the run.

Because of the small liner volume (about 120 microliters), the PTV has a limited injection capacity with hot split introduction. Injection volumes exceeding 1 μL in the hot split mode may overflow the inlet causing analytical problems. Cold split introduction avoids this potential problem.

Setting parameters for split mode operation

Mode: The current operating mode—split or pulsed split

Temperature Actual and setpoint inlet temperatures.

Initial temperature Starting temperature for the inlet.

Initial time Hold time at the inlet initial temperature.

Rate # Temperature program rates for inlet thermal ramps.

Final temp # Final inlet temperature for ramps 1, 2, and 3.

Final time # Hold time at Final temp 1, 2, and 3.

Pressure Actual and setpoint inlet pressure. Controls capillary column flow and linear velocity.

Split ratio The ratio of split flow to column flow. Column flow is set in the column parameter list. This line does not appear if a column in the flow path is not defined.

Split flow Flow, in mL/min, from the split/purge vent. This line does not appear if a column in the flow path is not defined.

Total flow These are the actual and setpoint values of the total flow into the inlet, which is the sum of the split flow, column flow, and septum purge flow. When you change the total flow, the split ratio and split flow change while the column flow and pressure remain the same.

Septum Purge Flow through the septum purge vent.

Gas saver On to reduce split vent flow at **Saver time**.

Saver flow Reduced split vent flow, at least 15 mL/min.

Saver time Time when flow is reduced to save gas.

If all columns in the flow path are defined

- 1 Press [**Front Inlet**].
- 2 Scroll to **Mode:** and press [**Mode/Type**]. Select **Split** or **Pulsed split**.
- 3 Set the inlet temperature (**Initial temperature**) and any desired ramps.
- 4 If you want a specific split ratio, scroll to **Split ratio** and enter that number. The split flow will be calculated and set for you.
- 5 If you want a specific split flow, scroll to **Split flow** and enter that number. The split ratio will be calculated and displayed for you.
- 6 If you selected **Pulsed split**, enter values for **Pulsed pressure** (pressure at injection) and **Pulse time** (minutes after injection to return to normal pressure).
- 7 If desired, turn on **Gas saver**. Set the **Saver time** after the injection time.
- 8 Press [**Prep Run**] before manually injecting the sample if the Gas Saver is on (see [“Pre Run and Prep Run”](#) on page 40).

If a column in the flow path is not defined

- 1 Press [**Front Inlet**].
- 2 Set the inlet temperature (**Initial temperature**) and any desired ramps.
- 3 Set other parameters as described for a defined column.
- 4 Set **Total flow** into the inlet. Measure flows out of the split vent and septum purge vent using a flow meter.

- 5 Subtract the septum purge flow and split vent flow from **Total flow** to get column flow.
- 6 Calculate the split ratio (split vent flow/column flow).
Adjust as needed

PTV inlet splitless and pulsed splitless modes

In these modes—with or without a pressure pulse—the split vent valve is closed during injection and vaporization of the sample and stays so while the sample transfers to the column.

At a specified time after injection, the valve opens to sweep vapors left in the liner out the split vent. This avoids solvent tailing due to the large inlet volume and small column flow rate.

The figures show the flows with the septum head. Flows with the septumless head are the same except that the septum purge flow bypasses the head.

Stage 1. Sample injection

With the split vent valve closed, the sample and solvent transfer to the column.

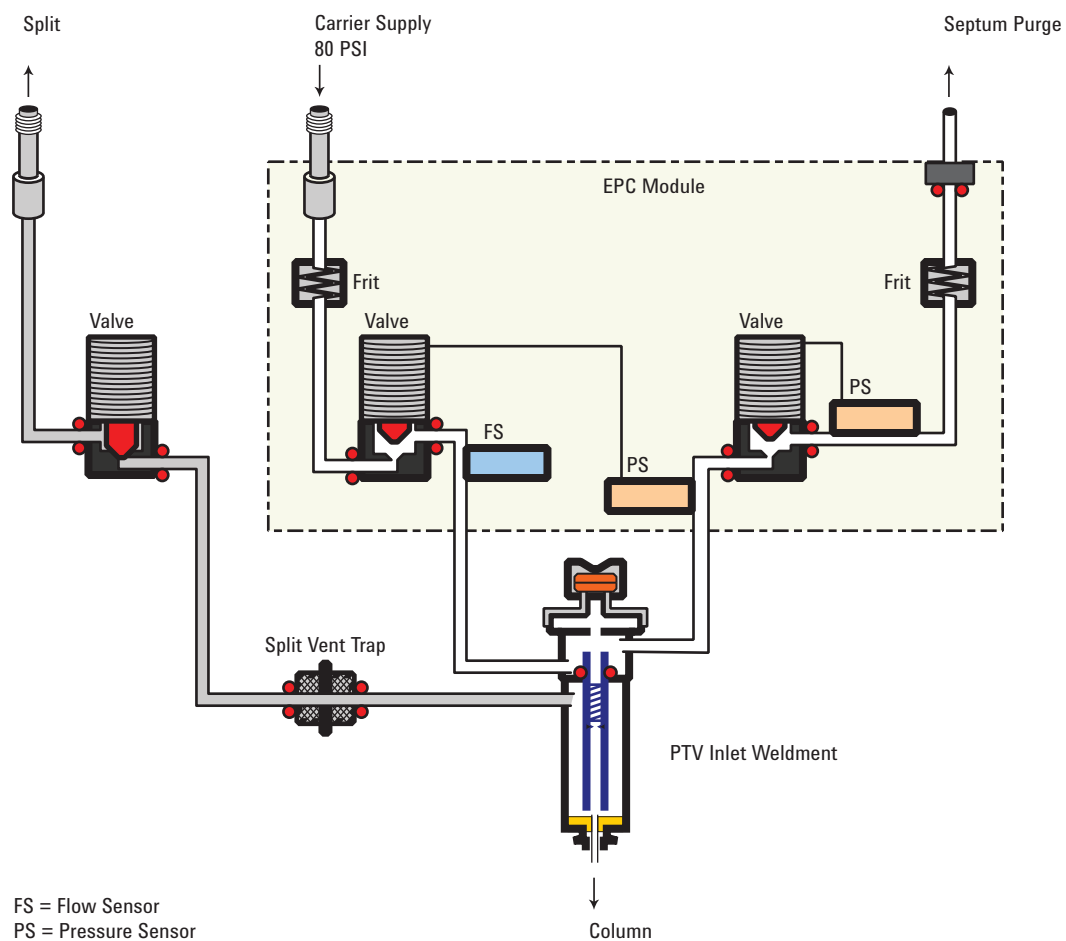

Stage 2. Solvent purging

After the sample has transferred to the column, the split vent valve opens to purge remaining solvent vapor from the inlet.

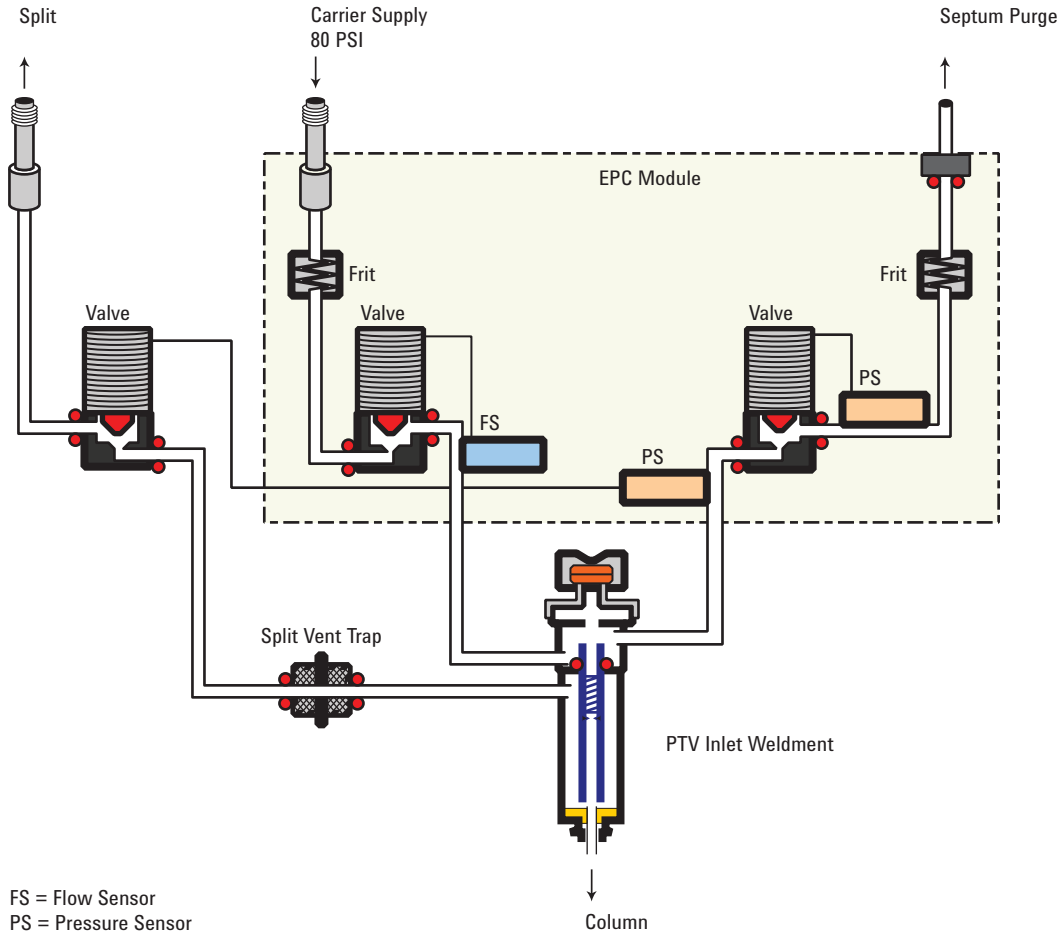

Timelines

This figure summarizes the flow, pressure, and temperature changes during a splitless mode analysis.

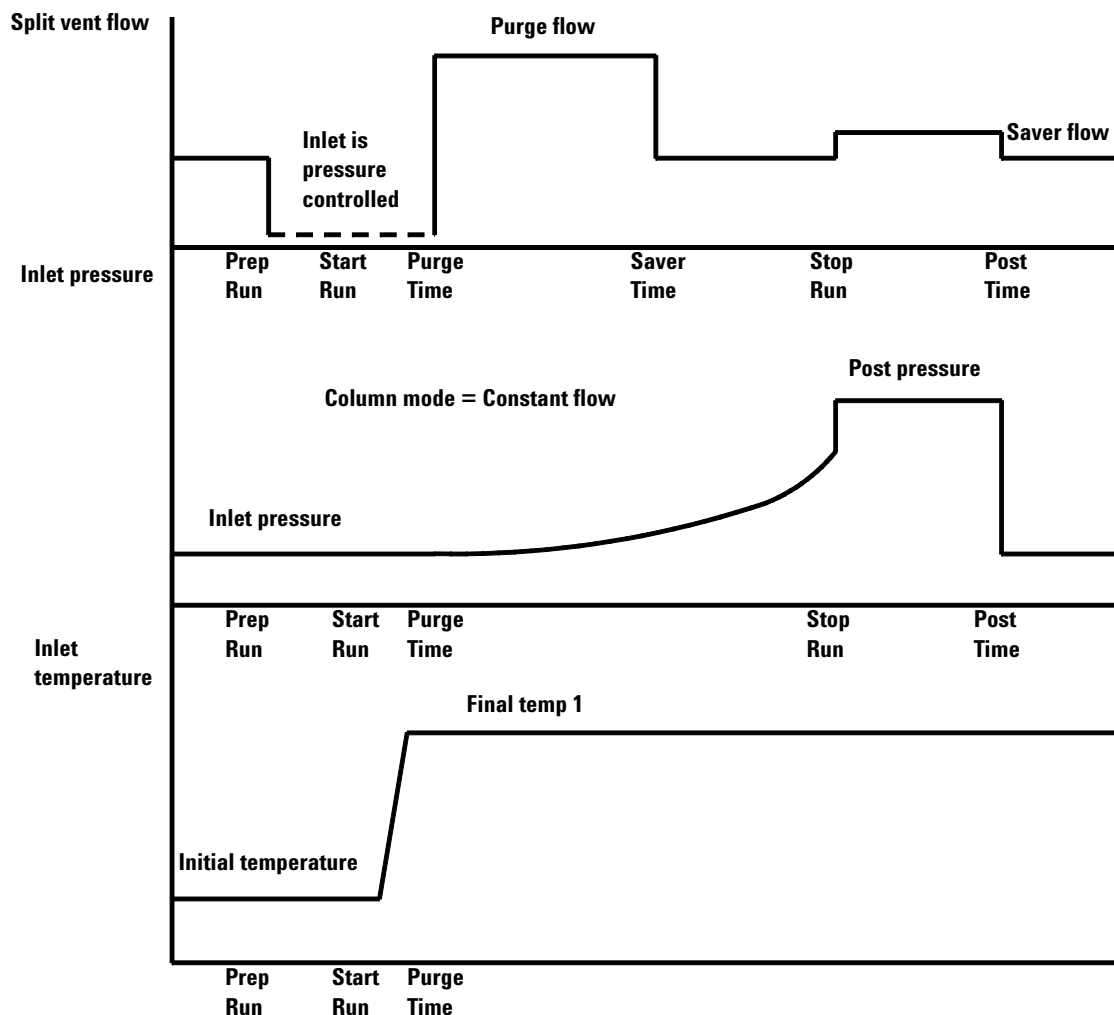

Cold splitless introduction

For cold splitless introduction, use an initial inlet temperature below the normal boiling point of the solvent. For most solvents, starting the first inlet temperature ramp at 0.1 minutes provides good transfer and reproducibility. A program rate of 500 °C/min or higher is appropriate for thermally stable analytes. A final temperature of 350 °C, held for 5 minutes, has quantitatively transferred up to C₄₄ alkane.

A main advantage of temperature programmability is that the inlet can be heated gently to transfer delicate analytes. If the oven temperature is initially low enough to refocus the analytes on the column, the inlet heating rate can be made slower (e.g., 120 °C/min). This reduces thermal degradation from the inlet and can improve peak shape and quantitation.

For most applications of cold splitless, a single temperature ramp is enough. The remaining ramps can be used to clean the liner or to decrease the inlet temperature to prepare for the next injection.

Hot splitless introduction

For hot splitless introduction, select an initial temperature high enough to volatilize the analytes. No additional temperature parameters are required as the inlet will maintain the setpoint throughout the run.

Because of the small liner volume (about 120 μL), the PTV cannot contain vapor resulting from large liquid injection volumes. Injection volumes greater than 1 μL may overflow vapor from the inlet, causing analysis variations. Cold splitless introduction avoids this problem.

Starting values

A successful splitless injection consists of these steps:

- 1 Inject the sample and temperature program the inlet to vaporize it.
- 2 Use a low column flow and low oven temperature to create a solvent-saturated zone at the head of the column.
- 3 Use this zone to trap and reconcentrate the sample at the head of the column.
- 4 Wait until all, or at least most, of the sample has transferred to the column. Then discard the remaining vapor in the inlet—which is mostly solvent—by opening a purge valve. This eliminates the long solvent tail that this vapor would otherwise cause.
- 5 Raise the oven temperature to analyze the sample.

Some experimentation is needed to refine the operating conditions. [Table 20](#) provides starting values for the critical parameters.

Table 20 Splitless mode inlet parameters

Parameter	Allowed setpoint range	Suggested starting value
Oven temperature	No cryo, ambient+10 °C to 450 °C CO ₂ cryo, -60 °C to 450 °C N ₂ cryo, -80 °C to 450 °C	10 °C below solvent boiling point

Table 20 Splitless mode inlet parameters (continued)

Parameter	Allowed setpoint range	Suggested starting value
Oven initial time	0 to 999.9 minutes	≥ Inlet purge time
Inlet purge time	0 to 999.9 minutes	$\frac{2 \times \text{Liner volume}}{\text{Column flow}}$
Gas saver time	0 to 999.9 minutes	After purge time
Gas saver flow	15 to 1000 mL/min	15 mL/min greater than maximum column flow
Inlet temperature	No cryo, oven temp + 10 °C CO ₂ cryo, -50 °C to 450 °C N ₂ cryo, -60 °C to 450 °C	10 °C below solvent boiling point for 0.1min, then ramp up

Setting parameters for the splitless modes

Mode: The current operating mode—Splitless or Pulsed splitless.

Temperature Actual and setpoint inlet temperatures.

Initial time Hold time at the initial inlet temperature.

Rate # Temperature program rates for inlet thermal ramps.

Final temp # Final inlet temperature for ramps 1, 2, and 3.

Final time # Hold time at Final temp 1, 2, and 3.

Pressure Actual and setpoint inlet pressure in psi, bar, or kPa

Pulsed pres The inlet pressure you desire at the beginning of a run. The pressure rises to this setpoint after [Prep Run] is pressed and remains constant until **Pulse time** elapses, when it returns to **Pressure**.

Pulse time Pressure returns to its normal setpoint at this time.

Purge time The time, after the beginning of the run, when you want the split vent valve to open.

Purge flow The flow, in mL/min, from the split vent, at **Purge time**. You will not be able to specify this value if operating with your *column not defined*.

Total flow The Total flow line displays the actual flow to the inlet during a Pre-run (Pre-run light is on and *not* blinking) and during a run before purge time. You cannot enter a setpoint at these times. At all other times, Total flow will have both setpoint and actual values.

Septum purge Flow through the septum purge vent

Gas saver On to reduce split vent flow at **Saver time**

Server flow Reduced split vent flow, at least 15 mL/min

Server time Time when flow is reduced to save gas

If the column is defined

- 1 Press [**Front Inlet**].
- 2 Scroll to **Mode:** and press [**Mode/Type**]. Select **Splitless** or **Pulsed splitless**.
- 3 Set the inlet temperature and any desired ramps.
- 4 Enter a **Purge time** and a **Purge flow**.
- 5 If desired, turn **Gas saver** on. Make certain the time is set after the **Purge time**.
- 6 Press [**Prep Run**] (see “[Pre Run and Prep Run](#)” on page 40) before manually injecting a sample. This is automatic if an Agilent sampler is used.

If the column is not defined

- 1 Press [**Front Inlet**].
- 2 Scroll to **Mode:** and press [**Mode/Type**]. Select **Splitless** or **Pulsed splitless**.
- 3 Set the inlet temperature and any desired ramps.
- 4 Enter a **Purge flow**.
- 5 Enter the **Purge time** when you wish the split valve to open.
- 6 Set **Total flow** greater than the column flow plus the septum purge flow to guarantee adequate column flow.
- 7 Turn **Gas saver** on, if desired. Set the time after **Purge time**.

- 8 Press [**Prep Run**] (see [“Pre Run and Prep Run”](#) on page 40) before manually injecting a sample. This is automatic if an Agilent sampler is used.

PTV inlet solvent vent mode

This mode is typically used for large volume injections. For single injection use a 50 or 100 μL syringe with variable plunger speed—slowly, 5 to 30 seconds.

The sample is injected into a cold inlet. If conditions are properly chosen and the sample is suitable, analytes deposit in the inlet liner while the solvent evaporates and is swept out. Large or multiple injections can be used to concentrate sample in the inlet before transferring to the column for analysis.

The figure shows the flows with the septum head. Flows with the septumless head are the same except that the septum purge flow bypasses the head.

Stage 1. Sample and vent

During sampling and venting, the split valve is open. The inlet is at **Initial temperature**, which is at or below the solvent boiling point.

Solvent vapors are swept out the vent, while sample deposits on the liner walls or packing.

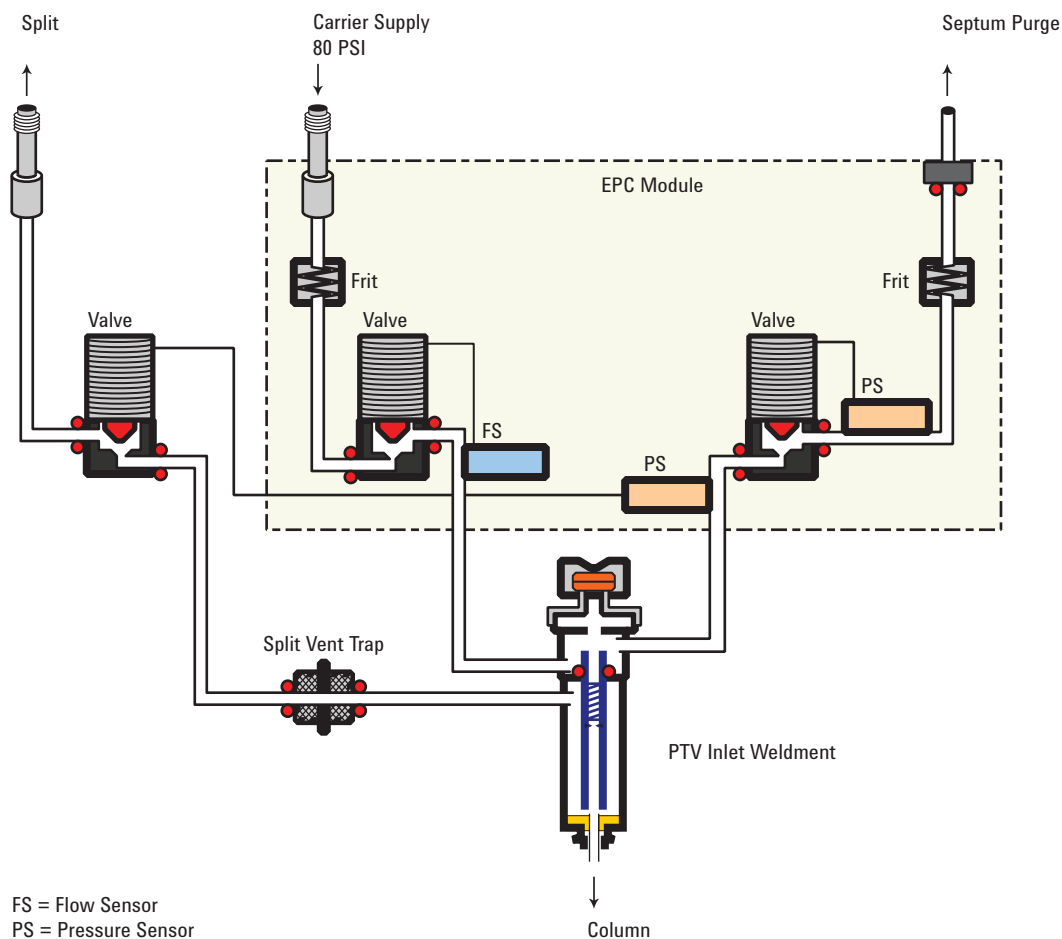

Stage 2. Sample transfer

When solvent venting ends, the split valve vent closes and the inlet heats to **Final temperature 1**. The sample transfers to the capillary column during **Purge delay** time.

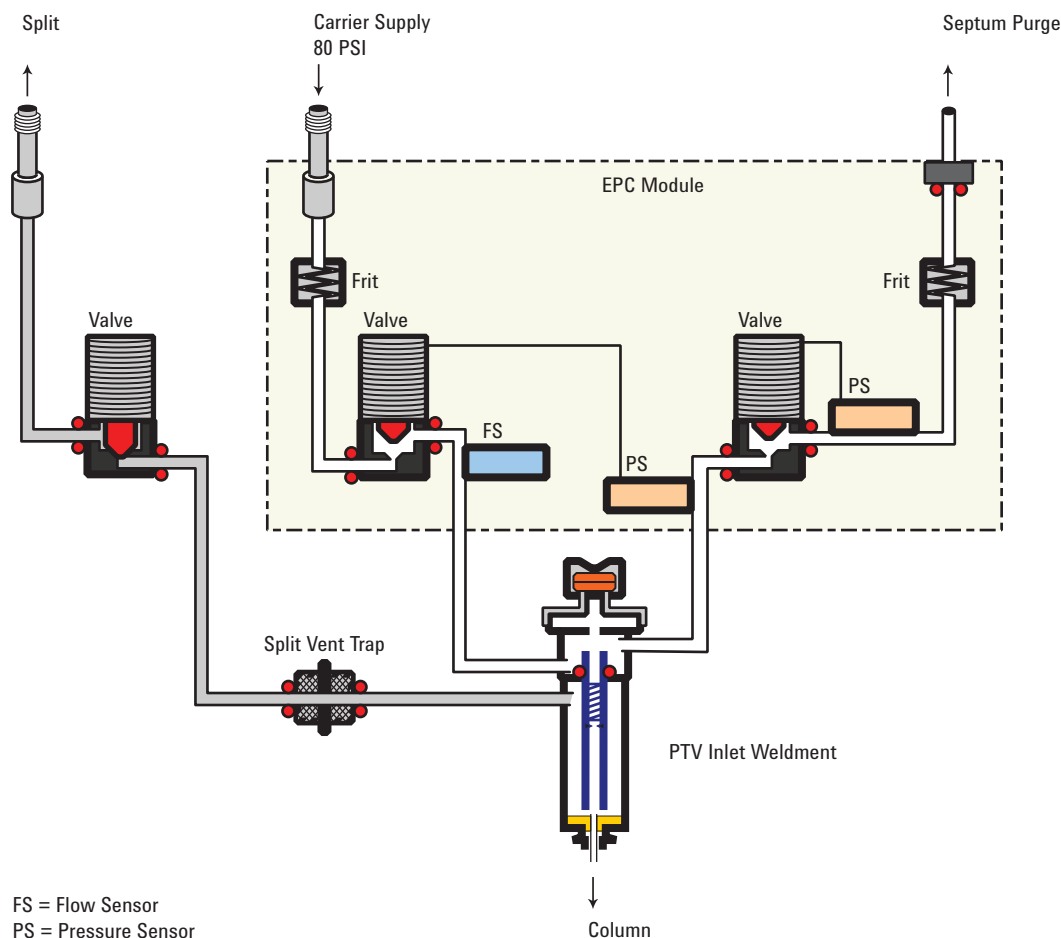

Stage 3. Purge and cleanup

The split valve opens again and the system returns to the Stage 1 configuration but with different setpoints. The PTV inlet is flushed. Additional ramp rates are available to thermally clean the inlet or to reduce inlet temperature after sample transfer. This can extend the life of the liner.

Temperature, pressure, and flow considerations

The solvent vent mode goes through three distinct pneumatic states; venting, sample transfer, and purging. The vent portion allows the inlet pressure and the vent flow to be adjusted to optimize solvent elimination. The transfer state

mimics traditional splitless operation and transports the analytes from the liner to the column. The purging mode allows the user to prepare the inlet for the next run.

A fundamental difficulty with solvent vent mode is the potential loss of volatile analytes with the solvent. Several solutions are possible for this situation:

- The inlet liner can be packed with a more retentive material, such as Tenax. This greatly improves volatile analyte recovery but may impact recovery of higher boiling materials.
- Some of the solvent can be left in the liner when sample transfer begins. The residual solvent acts like a stationary phase and retains volatile material, but at the expense of a larger solvent peak.
- The inlet temperature can be reduced. This reduces the vapor pressure of the volatile analytes and permits higher recoveries.

Solvent removal can be speeded up by:

- Reducing pressure in the inlet during sample introduction—the **Vent pressure** parameter
- Increasing flow through the inlet—the **Vent flow** parameter

While all these possibilities do complicate use of the PTV, they provide increased flexibility and new potential to solve difficult problems.

Sequence of operations

These are the steps in a typical analysis using the solvent vent mode:

Table 21 The solvent vent process

Step	Parameter	Value
1	Before injection	Flow at split vent
		Inlet pressure
The system is resting, with Purge flow (or Saver flow, if on) through the inlet.		
2	Prep Run begins	Flow at split vent
		Inlet pressure
Setpoints change to prepare for injection. When GC is ready, the sample is injected. Inlet and oven temperature program Init times begin. Solvent venting and analyte trapping begin.		
3	At Vent end time	Flow at split vent
		None, split valve closed

Table 21 The solvent vent process (continued)

Step	Parameter	Value
	Inlet pressure	Column pressure setpoint
Solvent venting ends, analyte transfer begins as inlet heats up.		
4	At Purge time	Flow at split vent
		Purge flow setpoint
	Inlet pressure	Column pressure setpoint
Analyte transfer ends, inlet is purged of residual vapor. Analysis begins.		
5	At Saver time	Flow at split vent
		Saver flow setpoint
	Inlet pressure	Column pressure setpoint
Analysis ends, carrier flow reduced to save gas (if Saver is on).		

Some important points

- The flow through the column is governed by the pressure in the inlet. This is controlled, during the analysis part of the process, by the flow or pressure setpoint or program entered *for the column*.
- The controlling times must be in the order shown; Vent end time *before* Purge time and PTV temperature **Initial time** *before* Saver time.
- Vent end time must occur before the inlet starts to heat and release analytes.
- Purge time must occur before the oven begins to heat and move sample through the column.

Timelines

Time increases downward; all other quantities increase to the right.

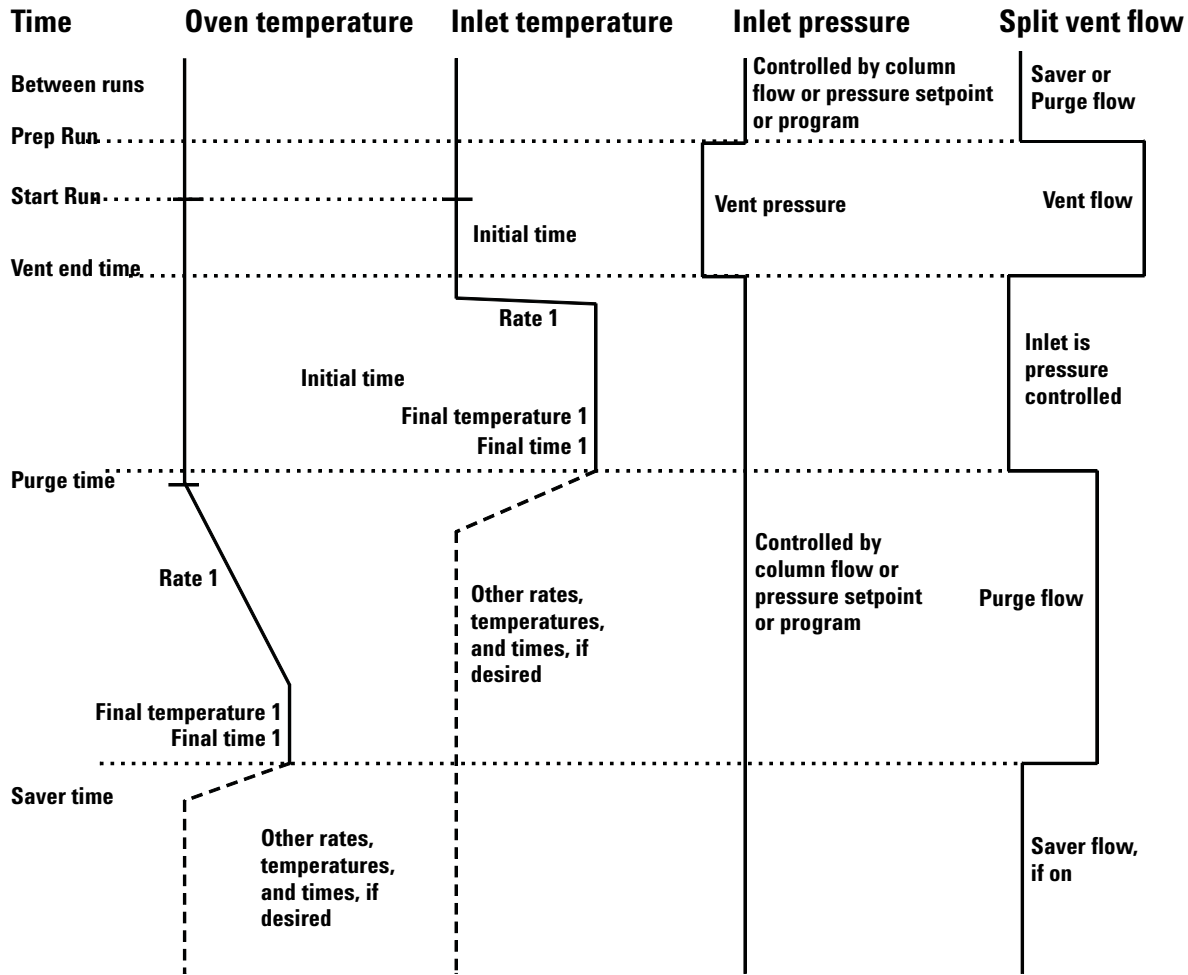

When is Start Run?

Both the inlet and oven temperature programs begin at Start Run. All times—such as Purge time—are measured from Start Run. When does Start Run occur?

- If the sample is injected manually, Start Run occurs when the user presses the **[Start]** key.
- If a single injection per run is made using an autosampler, Start Run occurs when the syringe carrier moves down to make the injection.
- If multiple injections per run are made using an autosampler, Start Run occurs when the syringe carrier moves down to make the first injection of the set. There are no Start Run signals for the rest of the injections in the set.

These additional injections take time. The inlet and oven temperature programs, mainly the **Initial time** values, must be adjusted to allow for this. So must the various time values that control the inlet operation. This is discussed in more detail under [“To develop a PTV method that uses large volume injection”](#) on page 115.

Setting parameters for solvent vent operation

Mode: The current operating mode—solvent vent.

Temperature Actual and setpoint initial inlet temperatures.

Initial time The time, measured from Start Run, when the initial inlet temperature hold ends. Must be greater than **Vent end time**.

Rate # Temperature program rate for inlet thermal ramps.

Final temperature # Final inlet temperature for ramps 1, 2, and 3.

Final time # Hold time at **Final temp #**. This time is a duration; it is *not* measured from Start Run.

Pressure Actual and setpoint inlet pressure before and after the vent period. It sets the starting point of column head pressure.

Vent pressure The inlet pressure during the vent period. By decreasing the inlet pressure while venting, solvent elimination proceeds faster. Also, the pressure reduction decreases the amount of carrier gas—and solvent vapor—that enters the column during this time.

Users select from 0 to 100 psig. If 0 is chosen, the inlet uses the lowest pressure possible at the given vent flow. [Table 22](#) shows approximate values for this minimum at various vent flows of helium. Pressures less than those in the table are not possible unless the flow is reduced.

Table 22 Minimum attainable pressures

Vent flow (mL/min)	Actual vent pressure at “0” psig setpoint	Actual vent pressure at “0” kPa setpoint
50	0.7	5
100	1.3	10

Table 22 Minimum attainable pressures (continued)

Vent flow (mL/min)	Actual vent pressure at "0" psig setpoint	Actual vent pressure at "0" kPa setpoint
200	2.6	18
500	6.4	44
1000	12.7	88

Vent flow The flow of carrier gas out the split vent during the vent period. Higher flows sweep the liner more quickly and reduce the time for solvent elimination. For most columns, 100 mL/min vent flow eliminates solvent at an acceptable rate but puts minimal material on the column.

Vent end time The time, measured from Start Run, when solvent venting ends. For large volume injections, this time is normally greater than the time for the injection to complete.

Purge time The time, measured from Start Run, when sample transfer ends. It began at **Vent end time**.

Purge flow The flow of carrier gas to the inlet beginning at **Purge time**.

Total flow The actual flow into the inlet.

Septum Purge Flow through the septum purge vent

Gas saver On to reduce split vent flow at **Saver time**

Saver flow Reduced split vent flow, at least 15 mL/min

Saver time Time when flow is reduced to save gas

If the column is defined

- 1 Press [**Front Inlet**].
- 2 Scroll to **Mode:** and press [**Mode/Type**]. Select **Solvent vent**.
- 3 Enter a **Vent pressure**, a **Vent flow**, and a **Vent end time**.
- 4 Set the inlet temperature and ramps, as desired.
- 5 Enter a **Purge time** and a **Purge flow**.
- 6 If desired, turn **Gas saver** on. Make certain the time is set after the **Purge time**.

- 7 Press [**Prep Run**] (see [“Pre Run and Prep Run”](#) on page 40) before manually injecting a sample.

If the column is not defined

- 1 Set up the parameters as described for the defined column case.
- 2 Set **Total flow** greater than the column flow plus the septum purge flow to guarantee adequate column flow.

To develop a PTV method that uses large volume injection

This topic provides a recommended way to change from a splitless injection using a split/splitless inlet to a solvent vent mode injection using a programmable temperature vaporization inlet (PTV). It applies mainly to large volume injections (LVI) using a PTV, but the concepts can apply to general PTV use. This topic does not consider all items that can impact an analysis, for example the liner, solvent, analyte boiling points, or polarity. This topic also assumes knowledge of your data system—when to save a method, how to start a run, how to set up a single run, etc.

The main advantage of the PTV inlet's solvent vent mode is that you can inject slowly into the inlet, allowing large amounts of solvent to evaporate in the liner (not in the split vent line). This concentrates the analytes prior to injection. It requires an injector with variable speed injections, a “large” syringe, and knowledge of the sample and the solvent.

When developing a solvent vent method, the goal is to determine the injection rates and temperatures needed to evaporate the solvent at the rate it enters the inlet. The development technique is to gradually scale up to an injection amount that produces a useful response. The most significant parameters are:

Temperature Hold the inlet temperature at or slightly below the solvent boiling point until after all the sample has been injected. This is important so that you do not boil away more volatile analytes, or boil away the solvent in the needle and trap your analytes there. An additional point to consider is that the boiling point of the earliest eluting analyte should be 100 °C less than the boiling point of the solvent.

Injection speed Estimate the evaporation rate of solvent exiting the needle based on solvent type, inlet temperature, vent flow, and pressure. Start with about half that number. Note that you have to make sure that you configure the syringe properly. If not, you will over- or under-load the inlet.

Vent end time The vent end time setpoint must be greater than the time the needle spends in the inlet. If the vent time is too short, you will overload and contaminate the column and inlet. Adjust the vent time as you scale up the method.

If using a PTV with an MS, another tip for method development is to scan for solvent ions. Detecting the solvent ions can be useful in troubleshooting residual solvent bleed onto the column.

To develop a PTV method for large volume injection, try the following:

- 1 Determine a small injection volume that works on a split/splitless inlet in splitless mode or the PTV in splitless mode. Choose a volume that does not currently overload the inlet.
- 2 Start with a 5–10 uL syringe and make sure the syringe is properly configured in the instrument and data system.
- 3 Make sure the column is configured.
- 4 Set up the inlet to perform a 1 uL injection.

Use the splitless method conditions, except:

- Start with the inlet temperature cold, near but slightly below the solvent boiling point. For example, if using methylene chloride (boiling point 39 °C), start with a temperature of 30–39 °C.
 - Use **Splitless** mode.
 - Ramp to the normal splitless inlet temperature.
- 5 Note the response achieved.
 - 6 Next, change the inlet mode to **Solvent vent**.
 - 7 Check the injector timings.
 - a Install an empty sample vial in the injector turret or tray.
 - b Input the injection rate (**Sample Draw Speed**, **Sample Disp Speed**, and **Inject Dispense Speed** rates) for the injector and increase the injection volume to 5 uL.
 - c Enter draft Solvent vent parameters:

- Set a **Vent flow** of 100 mL/min as a starting point.
 - Keep the inlet isothermal for now.
 - Enter a **Vent pressure** of 0 psi (0 kPa) and **Vent end time** of 0.1 minutes.
- d Make an injection using the empty vial. Use a stopwatch or your GC's timer feature to time how long the needle is in the inlet.
- 8 Enter revised **Solvent vent** mode parameters.
- Set the method's **Vent end time** to be about 0.05 min longer than the time the needle spends in the inlet.
 - Set the inlet temperature **Initial time** to be about 0.05 min longer than the **Vent pressure** time.
 - Program the inlet to ramp quickly to the injection temperature. Make sure the ramp starts after the **Vent end time**.
 - Set the **Purge Flow** to 30 mL/min. Set the purge time to be the vent pressure **Vent end time** + 1 minute.
- 9 Make a 5 uL injection of your standard. You should see 5 times the response.

If the response of **all analytes** is too low:

- The dispense speed is too fast. Liquid was injected into the inlet and pushed out the vent.
- The vent time is too long. The inlet started to heat while the vent was open.

If the response of **early eluters** is too low:

- The inlet temperature is too high.
- The **Vent flow** is too high.

If the response of **late eluters** is too low:

- The purge time is too short.
- The final inlet temperature is too low.

- 10 If you need more injection volume and the 5 uL worked to give 5 times the response, change the syringe to a larger one, for example, 50 uL.
- 11 Set up the data system to perform a 25 uL injection.
- 12 Configure the syringe. Make sure the plunger speeds on the injector are still set properly.
- 13 Recheck the injector timings. See the step above.

- 14 Set a new vent time and initial inlet temperature time based on the new time the needle spends in the syringe.
- 15 Make a 25 uL injection of your standard. Again, you should see 5 times the response. If not, see step 13.
- 16 If you need more response, repeat steps 10 through 15 to increase to larger volume. See the next section. Try performing 5 x 5 uL injections, then 5 x 50 uL injections.

Multiple injections with the PTV inlet

The preferred technique for concentrating analytes in the inlet liner is to use a single, large volume injection. Using a high capacity syringe and one septum puncture reduces the possibility of contamination and generally improves results when compared against a multiple septum puncture technique. However, if needed, you can perform multiple septum punctures during the vent time. This technique requires an Agilent data system and automatic liquid sampler.

Data system requirements

An Agilent data system is necessary for multiple injection because the needed parameters are not available through the GC keyboard.

OpenLAB CDS All

MassHunter Workstation All

GC ChemStation Software revision B.04.01 SP1 or later

MSD ChemStation Software revision E.02.00 SP2 or later

EZChrom Software revision 3.3.2 or later

Setting parameters for the inlet in solvent vent mode

Set or configure the following parameters in the data system's 7890 Series GC method editor.

Syringe size – Verify the syringe size is configured correctly. The configured syringe size changes the available choices for injection volume.

Injection volume – Select the injection volume, then enter a number of injections. The total injection volume will be displayed.

Multiple Injection Delay – A pause time, in seconds, between injections. This is added to the minimum hardware cycle time.

Preinjection washes and pumps are performed only before the first injection of a multiple injection set.

Postinjection washes are performed only after the last injection in a multiple injection set.

An example

These values were used for a sample with a broad range of boiling points.

Table 23 General parameters

Name	Value
Sample	C ₁₀ to C ₄₄ hydrocarbons in hexane
Mode	Solvent vent
MMI liner	Glass wool packed
Injection volume	One 10.0 µL injection (25 µL syringe)
Injection speed	Fast
Column	30 m x 320 µm x 0.25 µm -5, part number 19091J-413
Column flow	4 mL/min constant flow

Table 24 Inlet parameters

Name	Value	Name	Value
Initial temp	40 °C	Rate 2 (off)	
Initial time	0.3 min	Pressure	15.6 psig
Rate 1	720 °C/min	Vent pressure	0.0 psig
Final temp 1	450 °C	Vent flow	100 mL/min
Final time 1	5 min	Vent end time	0.2 min
Rate 2	100 °C/min	Purge time	2.0 min
Final temp 2	250 °C	Purge flow	50 mL/min
Final time 2	0 min		

Table 25 Oven parameters

Name	Value
Initial temp	40 °C
Initial time	2.5 min
Rate 1	25 °C/min
Final temp 1	320 °C
Final time 1	10.0 min
Rate 2 (off)	

Table 26 Detector parameters

Name	Value
Detector	FID
Detector temp	400 °C
Hydrogen flow	40 mL/min
Air flow	450 mL/min
Makeup (N ₂)	45 mL/min

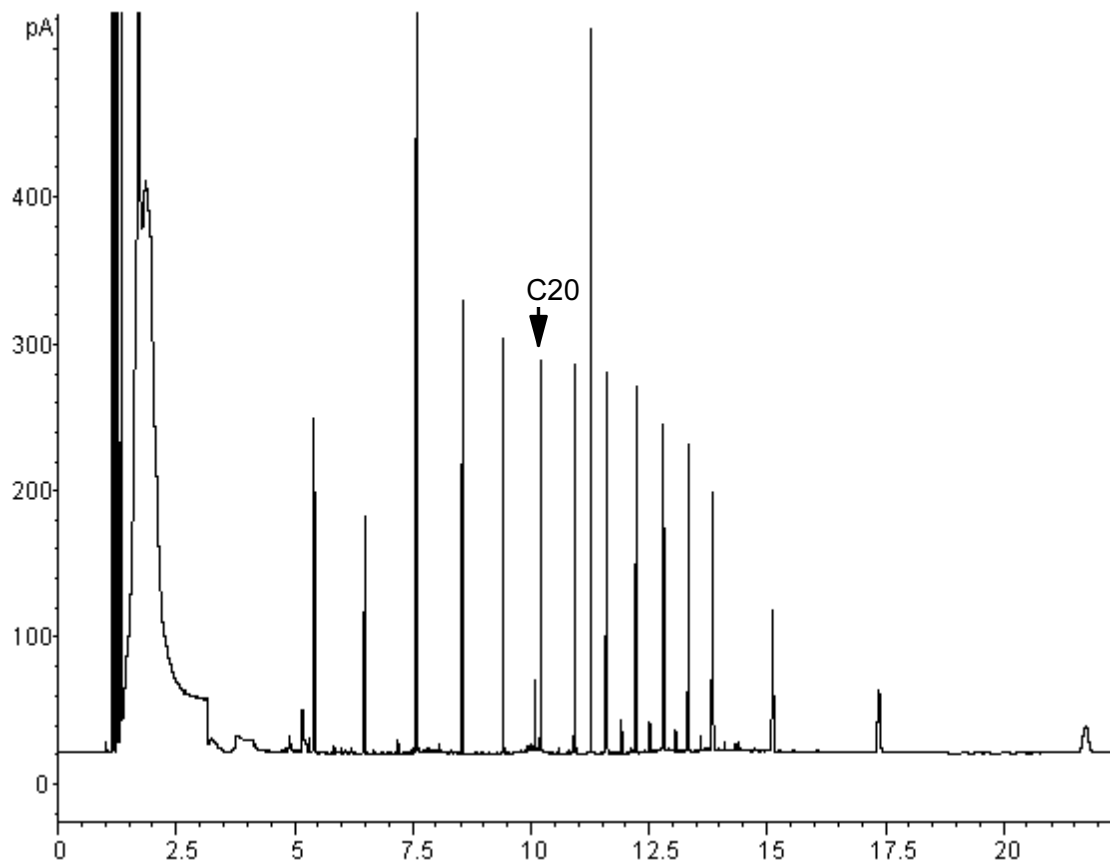

These results were compared with a splitless analysis of the same sample, which should produce 100% recovery of all analytes. The data showed that, under these conditions, compounds above C_{20} were completely recovered and that the recovery was independent of injection size. Compounds lower than C_{20} were partially vented with the solvent.

Possible adjustments

Depending on what you are trying to accomplish, you have a number of possible adjustments available.

To eliminate more solvent

- Increase the vent end time, inlet initial time, and purge time. This will not affect analytes that are quantitatively trapped but will eliminate more of the solvent peak.
- Increase the vent flow to sweep the liner more rapidly with the same inlet timing. Increasing vent flow raises vent pressure if it is set to 0. This puts more solvent onto the column.

- Raise the inlet initial temperature to vaporize more solvent and allow more to be eliminated. This also increases the loss of volatile analytes since their vapor pressures also increase.

To improve recovery of low boiling analytes

- Reduce inlet temperature to lower the vapor pressure of the analytes and trap them more effectively. This also reduces solvent vapor pressure and more time will be needed to eliminate it.
- Use a retentive packing in the liner. Materials such as Tenax permit higher recovery of volatile analytes but may not release higher boiling compounds. This must be considered if quantitation on these high boiling peaks is desired.
- Leave more solvent in the liner. The solvent acts as a pseudo stationary phase and helps retain volatile analytes. This must be balanced against the detector's tolerance for solvent.

An example—continued

The single injection example shown on the last few pages makes it clear that a 10 μL injection does not overload the glass wool packed liner. This means that multiple 10 μL injections are possible.

It was decided to make 10 injections per run, each of 10 μL size. This would increase analytical sensitivity substantially. No adjustments were made to improve recovery of the low boilers since the purpose of this analysis was to detect and measure the high boiling components.

After timing a trial set of 10 injections, the total time for the multiple injection set was measured to be approximately 1.3 minutes. The following timing changes were made:

Table 27 Modifications

Parameter	Increased from	To
Inlet Init time	0.3 minutes	1.6 minutes
Vent end time	0.2 minutes	1.5 minutes
Purge time	2.0 minutes	3.0 minutes
Oven Init time	2.5 minutes	3.0 minutes

The result is shown in the next figure. Note the difference in the vertical scale (5000 versus 500).

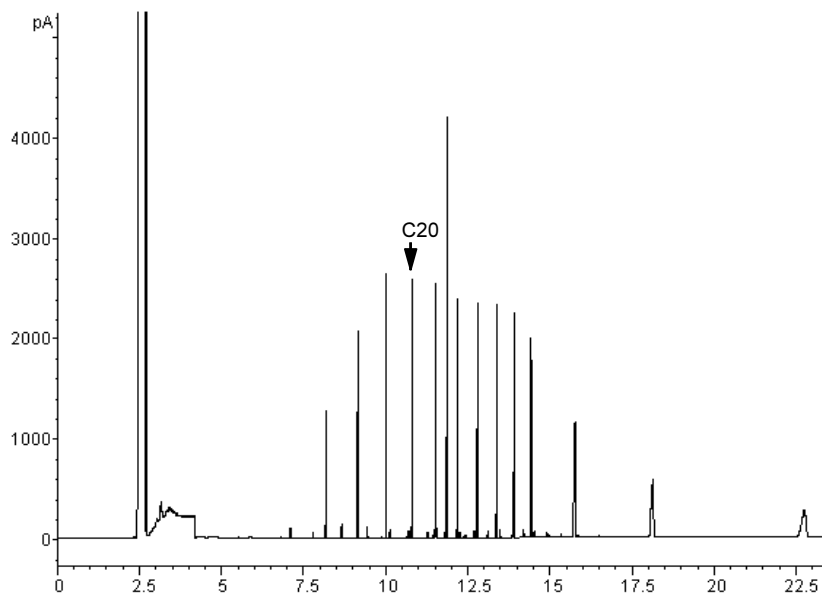

About the Volatiles Interface

The volatiles interface provides a simple, reliable way to introduce a gas sample into your GC from an external device such as a headspace, purge and trap, or air toxic sampler. Manual syringe injections cannot be made with this interface. The interface has a small volume and is highly inert, ensuring high sensitivity and resolution for applications requiring trace level detection.

The figure shows the pneumatics in the split mode.

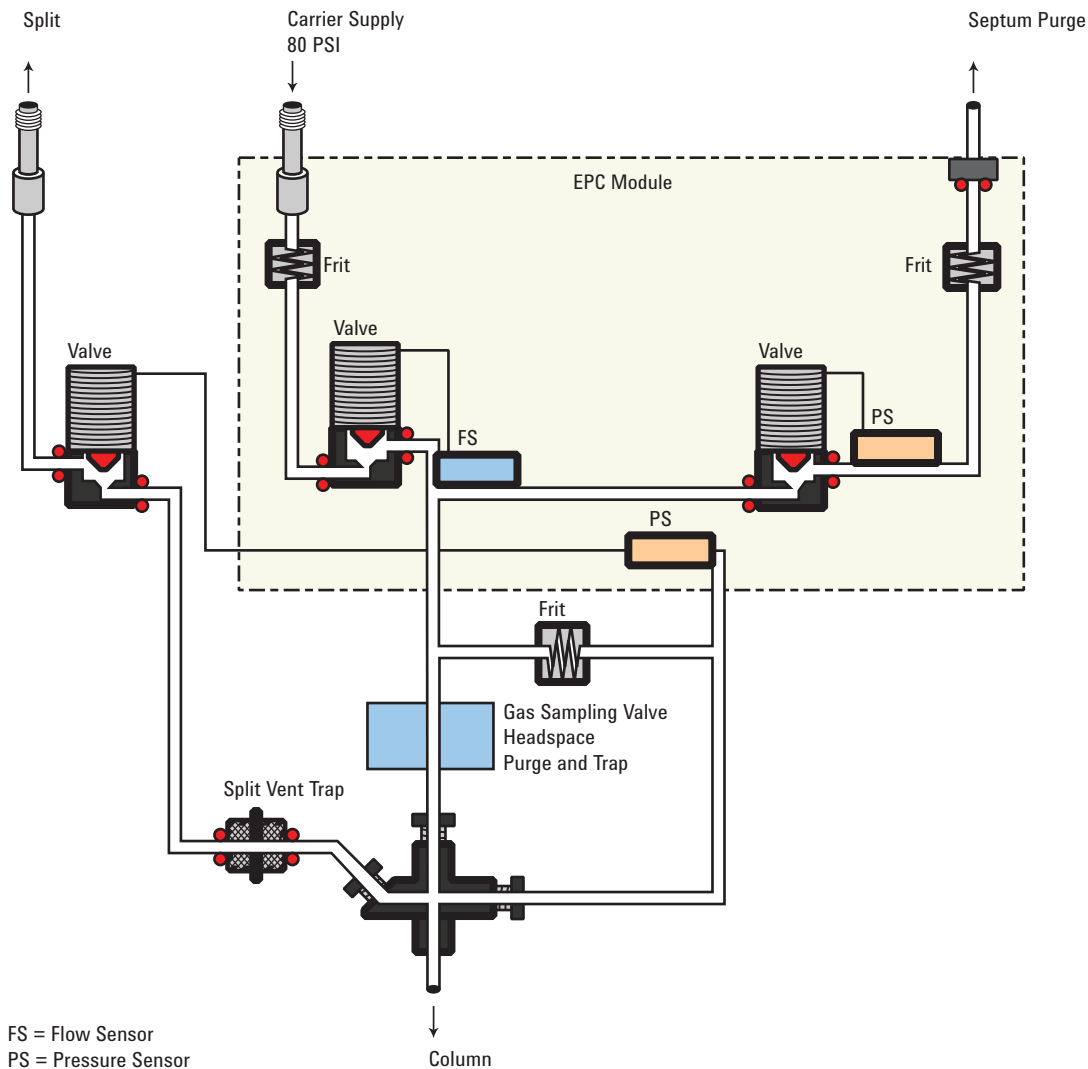

Total flow to the interface is measured by a flow sensor and is divided into two streams. One stream connects to the septum purge regulator; the other connects to a frit block. At the frit block, the flow is further divided. The first stream

goes to the gas-phase sampler and from there is introduced into the interface. The second stream, called the pressure sensing line, passes through the frit block and is measured by a pressure sensor. This stream also provides a trickle flow to the interface.

VI operating modes

There are three modes of operation—split, splitless, and direct. The pneumatics differ for each operating mode and are discussed in detail in the rest of this document.

[Table 28](#) summarize some issues to consider when choosing an operating mode. Specifications for the interface are also listed.

Table 28 Overview of the volatiles interface

Mode	Sample concentration	Sample to column	Comments
Split	High	Very little, most is vented	
Splitless	Low	All	Can switch to split mode electronically.
Direct	Low	All	Must physically disconnect split vent, plug the interface, and reconfigure the GC. Maximizes sample recovery and eliminates possibility of contamination to pneumatic system.

Table 29 Specifications of the volatiles interface

Specification	Value/Comment
Deactivated flow path	
Volume	32 μ L
Internal dimensions	2 mm by 10 mm
Maximum flow to interface	100 mL/min
Split range	Depends on column flow Typically no split to 100:1

Table 29 Specifications of the volatiles interface (continued)

Specification	Value/Comment
Temperature range	10 °C above ambient (with oven at ambient) to 400 °C
Recommended temperature:	≥ transfer line temperature of the external sampling device

About the VI split mode

When you introduce a sample in the split mode, a small amount of the sample enters the column while the major portion exits from the split vent. The ratio of split flow to column flow is controlled by the user. The split mode is primarily used for high concentration samples when you can afford to lose most of the sample out the split vent and for samples that cannot be diluted.

Split ratio

Because of the interface's small internal volume, the maximum total flow to the interface is 100 mL/min. This maximum flow puts some restriction on the split ratio you can set.

Table 30 Maximum split ratios

Column diameter (mm)	Column flow (mL/min)	Maximum split ratio	Total flow (mL/min)
0.20	1	100:1	100
0.53	5	20:1	100

Split mode pneumatics

During Pre Run, during sampling, and after sampling, total flow to the interface is measured by a flow sensor and controlled by a proportional valve. Flow at the head of the column is back-pressure regulated. Pressure is sensed upstream from the proportional valve.

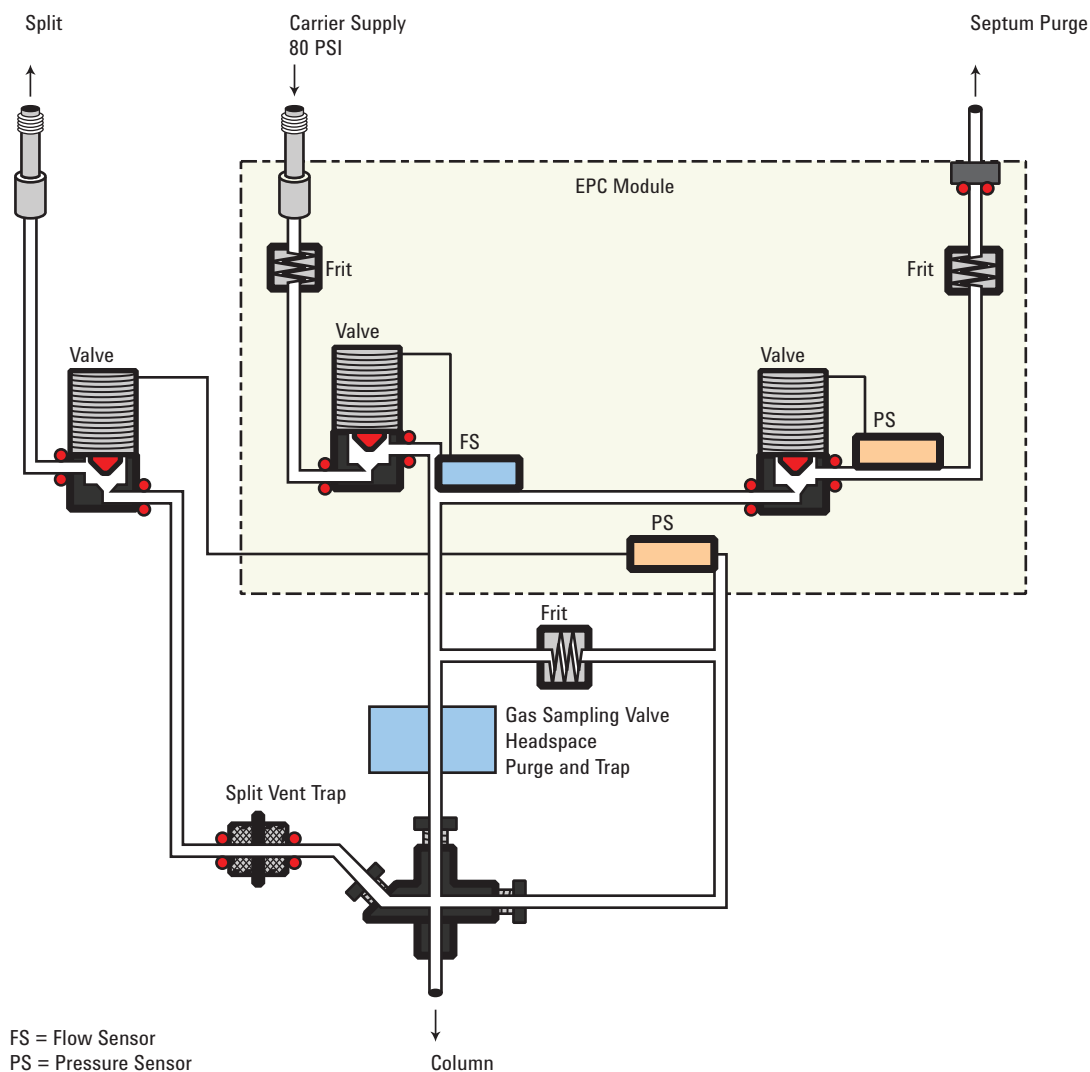

Setpoint dependencies

Some setpoints are interdependent. If you change one setpoint, other setpoints may change to compensate. With a defined capillary column, setting column flow or linear velocity will set the inlet pressure.

Table 31 Setpoint dependencies

When you change	These setpoints change	
	Column defined	Column not defined
Pressure	Column flow* Split flow Total flow	No changes

Table 31 Setpoint dependencies (continued)

When you change	These setpoints change	
	Column defined	Column not defined
Column flow [*]	Pressure Split flow Total flow	not available
Split flow	Split ratio Total flow	not available
Split ratio	Split flow Total flow	not available
Total flow	Split flow Split ratio	No changes

* This setpoint appears in [Col 1] or [Col 2].

Initial values

Use the information in [Table 32](#) to help you set up the operating conditions for your interface.

Table 32 Suggested starting values

Parameter	Allowed setpoint range	Suggested starting value
Oven initial time	0 to 999.9 minutes	After sample on column
Interface temperature	Ambient + 10 °C to 400 °C	≥ Transfer line temperature
Gas saver time	0 to 999.9 minutes	After sample on column
Gas saver flow	15 to 100 mL/min	15 mL/min greater than maximum column flow

Setting parameters for the split mode

Mode: The current operating mode—split

Temperature Actual and setpoint interface temperatures

Pressure Actual and setpoint interface pressure. Controls capillary column flow.

Split ratio The ratio of split flow to column flow. Column flow is set using [Col 1] or [Col 2]. This parameter is not available if your column is not defined.

Split flow Flow, in mL/min, from the split vent. This parameter is not available if your column is not defined.

Total flow The total flow into the interface, both setpoint and actual

Septum Purge Flow through the septum purge vent

Gas saver On to reduce split vent flow at **Saver time**

Saver flow Reduced split vent flow, at least 15 mL/min.

Saver time Time when flow is reduced to save gas

If the column is defined

- 1 Press [Front Inlet] or [Back Inlet].
- 2 Scroll to **Mode:** and press [Mode/Type]. Select **Split**.
- 3 Set the interface temperature.
- 4 If you want a specific split ratio, scroll to **Split ratio** and enter that number. The split flow will be calculated and set for you.
- 5 If you want a specific split flow, scroll to **Split flow** and enter that number. The split ratio will be calculated and set for you.
- 6 If desired, turn **Gas saver** on. Set **Saver time** after the sample has been introduced.
- 7 If **Gas saver** is on, be certain **Auto prep run** is On (see “Pre Run and Prep Run” on page 40) or press [Prep Run] before introducing the sample.

If the column is not defined

- 1 Press [Front Inlet] or [Back Inlet].
- 2 Scroll to **Mode:** and press [Mode/Type]. Select **Split**.
- 3 Set the interface temperature.
- 4 Set **Total flow** into the interface. Measure flow out of the split vent using a flow meter.
- 5 Subtract the split vent flow from **Total flow**. Subtract the septum purge flow from the result to get column flow.

- 6 Calculate the split ratio (split vent flow/column flow). Adjust as needed.
- 7 If desired, turn **Gas saver** on. Set **Saver time** after the sample has been introduced.
- 8 If **Gas saver** is on, be certain **Auto prep run** is On (see “[Pre Run and Prep Run](#)” on page 40) or press [**Prep Run**] before introducing the sample.

About the VI splitless mode

This mode is used to concentrate sample at the head of the GC column during desorb. Purge timing delay must take into consideration the volume of the loop or trap in the external sampler plus the transfer line versus desorb/total flow rate. Cryo focussing is required for very volatile samples in splitless mode.

When you introduce a sample, the split valve remains closed while the sample enters the interface and is transferred to the column. At a specified time after the sample is introduced, the split valve opens.

Splitless mode pneumatics

Before Pre Run When the GC is preparing for sample introduction, total flow to the interface is measured by a flow sensor and controlled by a proportional valve. Column flow is controlled via back-pressure regulation. The split valve is open.

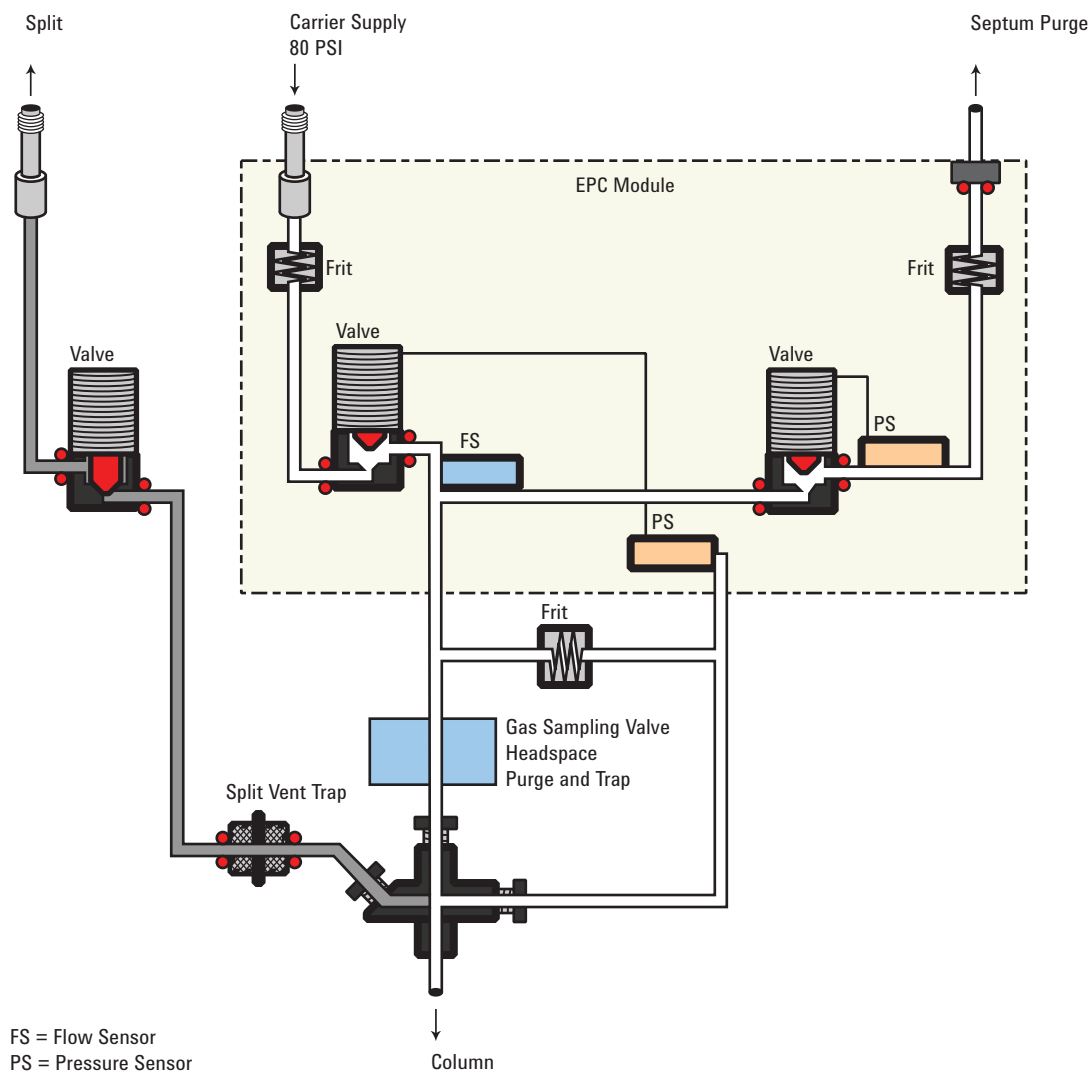

During sampling Pressure upsets caused by switching valves and trap restrictions in the external sampling device can cause fluctuations in column flow rates. To compensate for this, the interface is flow controlled during sampling time. The sampling flow rate is calculated from the pressure setpoint that is active when sample introduction begins. This flow control starts when the GC goes into the Pre Run state (when your system is automated and the Pre Run light is on or during manual operation when you press **[Prep Run]**) and ends after the interface's **Sampling end** setpoint expires.

Sampling end is required for purge and trap or thermal desorption systems and should be set \geq the sampler desorb time.

3 Inlets

During this user-specified sampling period, the solenoid valve is closed. Flow to the interface is measured by a flow sensor and controlled by a proportional valve.

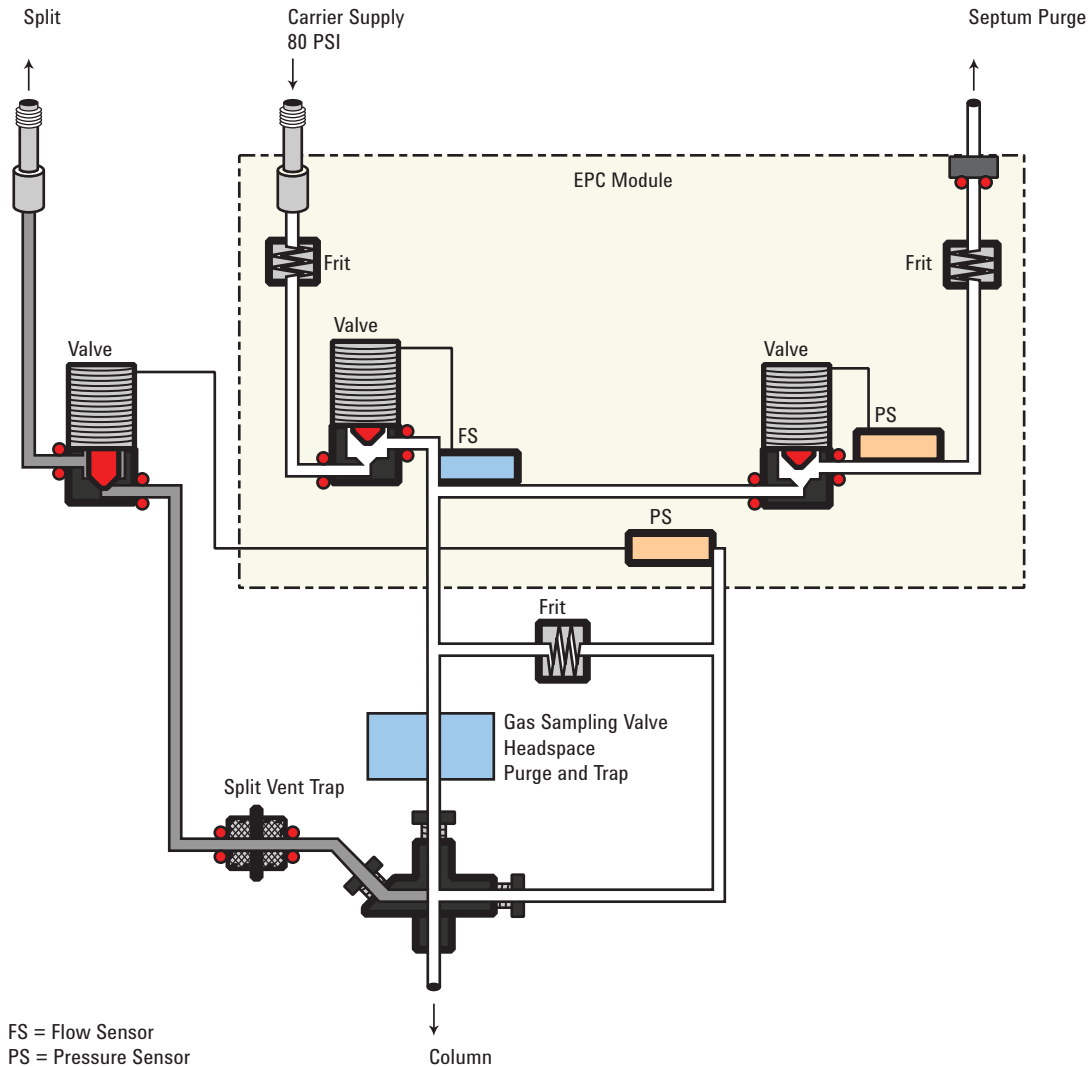

After sampling end The solenoid valve opens. The system returns to the **Before Prep Run** state. Flow to the interface is again measured by a flow sensor and controlled by a proportional valve while column flow is controlled via back-pressure regulation. The purge flow is controlled by the user. If desired, gas saver can be turned on at the end of the run.

Setpoint dependencies

Some setpoints in the flow system are interdependent. If you change one setpoint, other setpoints may change to compensate.

Table 33 Setpoint dependencies

When you change	These setpoints change	
	Column defined	Column not defined
Purging		You can change the Pressure and Total flow setpoints; other setpoints are not affected.
Purge flow	Total flow**	
Pressure	Total flow** Column flow*	
Column flow*	Pressure Total flow**	
Before and after sampling, not purging		You can change the Pressure setpoint; other setpoints are not affected.
Pressure	Column flow* Total flow**	
Column flow*	Pressure Total flow**	
During sampling:	You cannot change pressure and flow setpoints during sampling time.	

* This setpoint appears in the column parameters.

**This value is actual only.

Initial values

The table shows recommended starting values for selected parameters.

Table 34 Suggested starting values

Parameter	Allowed setpoint range	Suggested starting value
Oven initial time	0 to 999.9 minutes	≥ Interface purge time
Interface temperature	Ambient + 10 °C to 400 °C	≥ Transfer line temperature
Interface sampling end	0 to 999.9 minutes	0.2 minutes longer than introduction time
Interface purge time	0 to 999.9 minutes	
Gas saver time	0 to 999.9 minutes	Must be after purge time
Gas saver flow	15 to 100 mL/min	15 mL/min greater than maximum column flow

Setting parameters for the VI splitless mode

Mode: The current operating mode—splitless

Temperature Actual and setpoint interface temperatures. Column temperature must be low enough to cold trap the volatile sample. Cryo focussing is recommended.

Sampling end The sample introduction interval, in minutes. The flow rate is calculated from the pressure setpoint that is active at the start of sample introduction.

Set the sampling end setpoint 0.2 minutes longer than the time the sampler needs to introduce the sample. For example, the 7694 headspace sampler has an Inject time parameter which controls how long the valve remains in the inject position. If Inject time is 1 minute, the sampling end setpoint should be set to 1.2 minutes. If you're using an 7695 Purge and Trap Concentrator, set **Sampling end** 0.2 minutes longer than the Desorb time parameter.

If your column is defined and you specify a flow or pressure program for your column, the ramp does not begin until after the sampling end setpoint expires.

Pressure Actual and setpoint interface pressure in psi, bar, or kPa.

Purge time The time, after the beginning of the run, when purging resumes. **Purge time** must be greater than **Sampl'g end**.

Purge flow The flow, in mL/min, from the split vent at **Purge time**. You will not be able to access or specify this value if your column is not defined.

Total flow When your column is defined, **Total flow** displays the actual flow to the interface. You cannot enter a setpoint. If your column is not defined, **Total flow** will have both setpoint and actual values during purge time. All other times, the actual flow to the interface is displayed.

Septum Purge Flow through the septum purge vent, at least 15 mL/min.

Gas saver On to reduce split vent flow at **Saver time**.

Saver flow Flow through the split vent after **Saver time**.

These instructions apply to both column *defined* and *not defined*.

- 1 Press [**Front Inlet**] or [**Back Inlet**].
- 2 Scroll to **Mode:** and press [**Mode/Type**]. Select **Splitless**.
- 3 Set the interface temperature and a sampling end time.
- 4 If your column is defined, enter a **Purge time** and **Purge flow**. Turn **Gas saver** on if desired. Set the **Gas saver time** *after* the purge time and enter a Gas saver flow.
- 5 If your column is not defined, enter a **Purge time** (**Purge flow** is not available). Set **Total flow** greater than column flow plus septum purge flow to guarantee adequate column flow.
- 6 Make certain **Auto Prep Run** is **On** (see “[Pre Run and Prep Run](#)” on page 40) or press [**Prep Run**] before introducing a sample.

About the VI direct mode

Direct sample introduction permits a quantitative transfer of analyte without risking contamination to the pneumatic system. It provides the sensitivity required for air toxic analyses. The interface’s minimal dead volume also eliminates the potential interaction of solutes with poorly swept, active surfaces.

To operate in the direct mode, you must physically disconnect the split vent and reconfigure the GC.

Before Pre Run

The interface is forward pressure controlled; pressure is sensed downstream from the flow proportional valve.

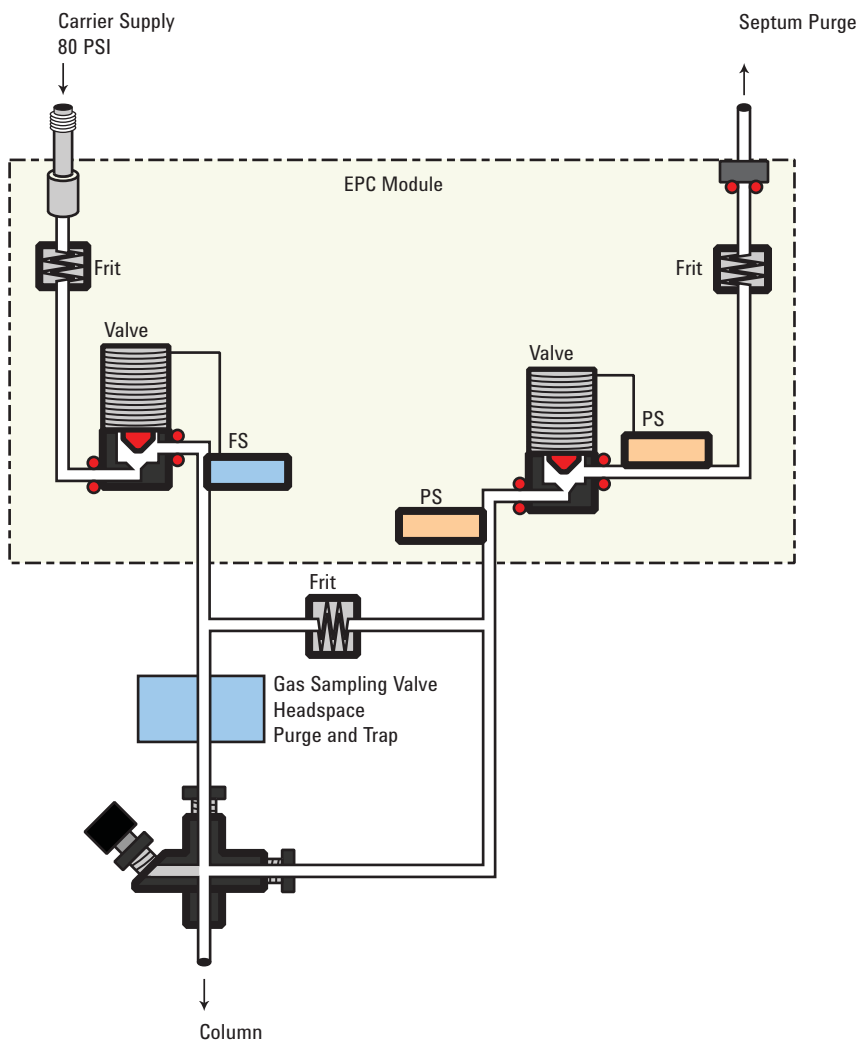

During sampling

Pressure upsets caused by switching valves in the external sampler can cause fluctuations in column flow rates. To compensate for this, the interface is flow controlled during sampling time. The sampling flow rate is calculated from the pressure setpoint that is active when sample introduction begins. This flow control starts when the GC goes into the Pre Run state (when your system is automated and the Pre Run light is on or during manual operation when you press [Prep Run]) and ends after the interface's **Sampling end** setpoint expires.

Flow to the interface is measured by a flow sensor and controlled by a proportional valve.

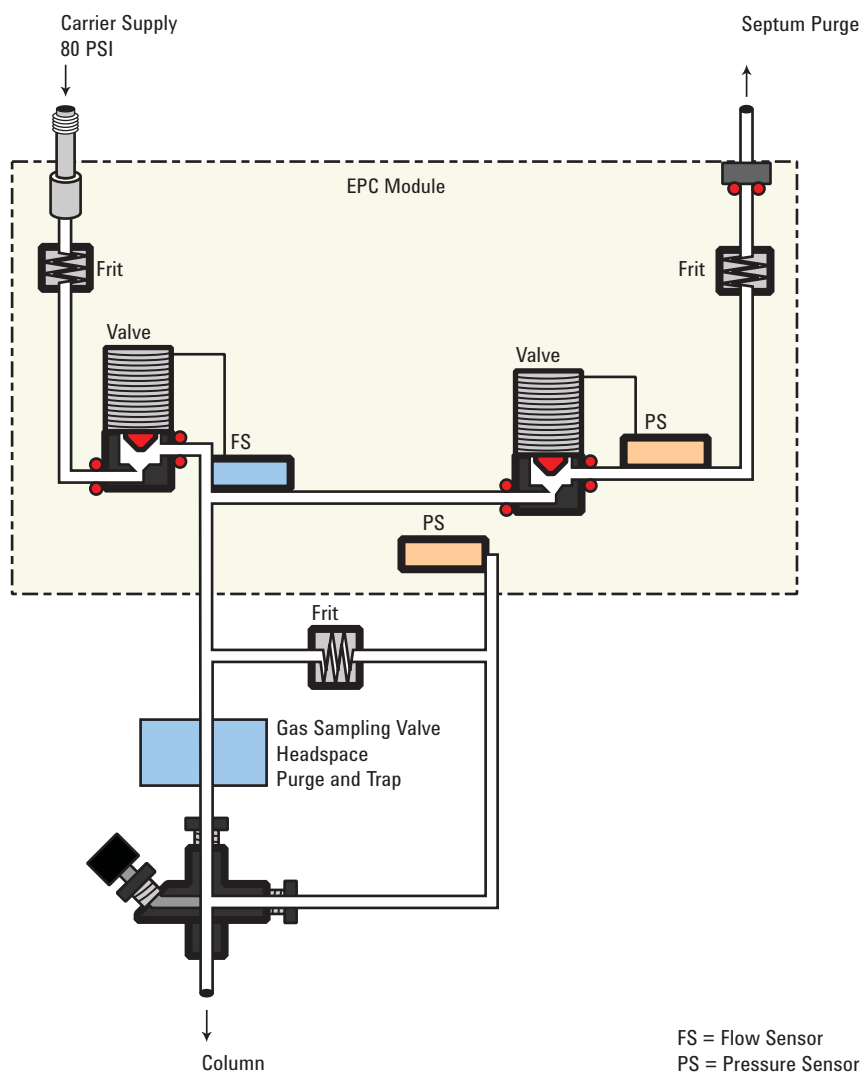

After sampling end

The interface is forward pressure controlled; pressure is sensed downstream from the proportional valve. The system returns to the idle state.

Preparing the Interface for Direct Sample Introduction

Before you can operate your interface in direct mode, you must:

- **Disconnect** the split vent line
- **Configure** the GC for a direct injection

Disconnecting the split vent line

WARNING

Be careful! The interface may be hot enough to cause burns.

- 1 Press **[Front Inlet]** or **[Back Inlet]**. Turn off the interface temperature and pressure and allow the interface to cool.
- 2 If desired, remove the transfer line by loosening the hex nut with a wrench.
- 3 Remove the clamping plate from the interface by loosening the captive screw with a screwdriver. Put the plate in a safe place.

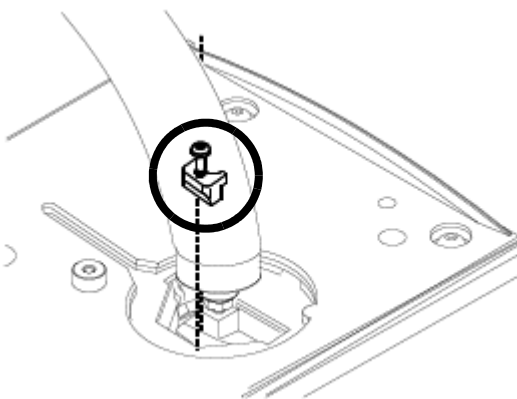

- 4 Carefully lift the interface out of the heater block.

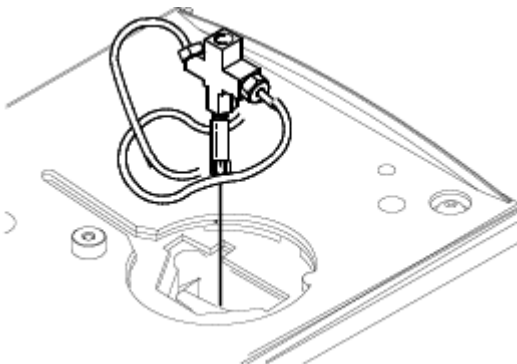

- 5 Loosen the hex nut connecting the split vent line to the interface until you can remove the line. Put the line aside. You do not need to plug it.

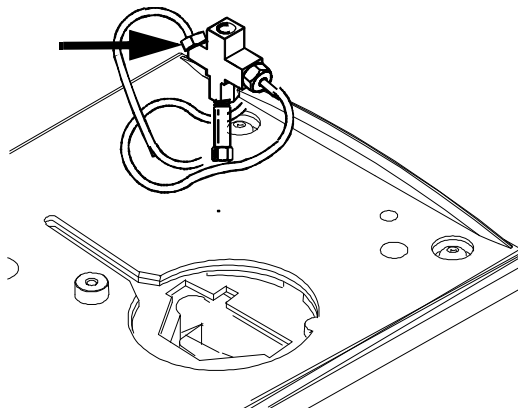

- 6 Install a blanking nut into the split line port and finger-tighten the nut. Tighten the nut an additional 1/4-turn using two wrenches in opposition.

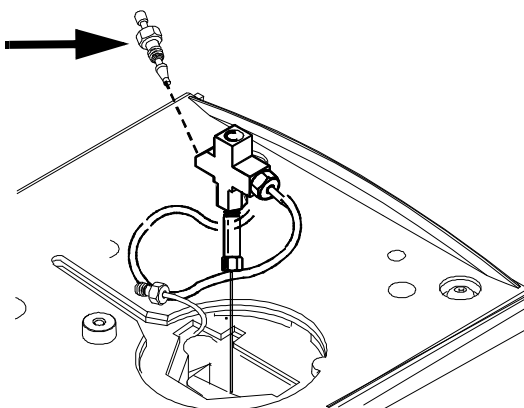

- 7 Place the interface in the heater block. Replace the clamping plate you removed earlier and tighten the screw until snug. Do not overtighten. If you removed the transfer line, replace it.

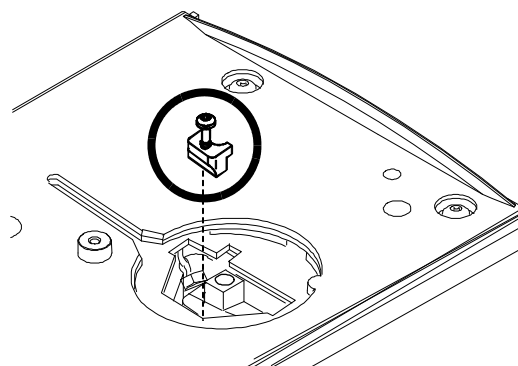

- 8 Restore the GC to normal operating conditions. Perform a leak test on the interface fittings.

Configuring the GC for a direct injection

The GC cannot sense the presence of the split vent. When you disconnect or reconnect the vent, you must configure the GC so that the pneumatics work properly.

- 1 Press **[Config][Back Inlet]** or **[Config][Front Inlet]**.
- 2 Scroll to **Mode** and press **[Mode/Type]**.
- 3 Select **Split vent removed**. Press **[Enter]**.
- 4 Press **[Back Inlet]** or **[Front Inlet]**. If the inlet is correctly configured, you will see the **Direct injection** display.

VI direct mode setpoint dependencies

Some setpoints in the flow system are interdependent. If you change one setpoint, other setpoints may change to compensate.

Table 35 Setpoint changes

When you change	These setpoints change	
	Column defined	Column not defined
Before and after sampling		The Column flow* setpoint is not available.
Pressure	Column flow* Total flow**	You can change the pressure setpoint; other setpoints are not affected.
Column flow*	Pressure Total flow**	
During sampling	You cannot change pressure and flow setpoints during sampling time.	

* This setpoint appears in the column parameters

**This value is actual only

VI direct mode initial values

Use the information in [Table 36](#) to help you set up the operating conditions for your interface.

Table 36 Suggested starting values

Parameter	Allowed setpoint range	Suggested starting value
Oven initial time	0 to 999.9 minutes	≥ interface sampling end
Interface temperature	Ambient + 10 °C to 400 °C	≥ transfer line temperature
Interface sampling end	0 to 999.9 minutes	0.2 minutes longer than actual sampling time

Setting parameters for the VI direct mode

Temperature Actual and setpoint interface temperatures

Sampling end The sample introduction interval, in minutes. The flow rate is calculated from the pressure setpoint that is active at the start of sample introduction.

Set **Sampling end** 0.2 minutes longer than the time the sampler needs to introduce the sample. For example, the 7694 headspace sampler has an **Inject time** parameter which controls how long the valve remains in the inject position. If **Inject time** is 1 minute, **Sampling end** should be set to 1.2 minutes. If you're using a 7695 Purge and Trap Concentrator, set **Sampling end** 0.2 minutes longer than the **Desorb time** parameter.

If your column is defined and you specify a flow or pressure program for your column, the ramp does not begin until after **Sampling end** expires.

Pressure Actual and setpoint interface pressure before a run and after sampling time.

Total flow The actual flow to the interface. This is a reported value, not a setpoint.

Septum Purge Flow through the septum purge vent, range 0 to 30 mL/min.

These instructions apply to both column defined and column not defined.

- 1 Press [**Front Inlet**] or [**Back Inlet**].
- 2 Confirm that your GC is configured for direct injection.
- 3 Set the interface temperature.

3 Inlets

- 4 Set **Sampling end** at 0.2 minutes longer than the sample introduction time.
- 5 Make certain **Auto Prep Run** is On (see “[Pre Run and Prep Run](#)” on page 40) or press [**Prep Run**] before introducing a sample.



4 Columns and Oven

About the Oven	144
Oven safety	144
Configuring the Oven	145
Cryogenic Operation	146
Cryogenic setpoints	146
About Oven Temperature Programming	148
Programming setpoints	148
Oven ramp rates	149
Setting the oven parameters for constant temperature	150
Setting the oven parameters for ramped temperature	150
About the Oven Insert	152
Selecting the correct packed glass column type	153
About the column modes	153
Select a column mode	154
Setting the column parameters for constant flow or constant pressure	155
Enter a flow or pressure program (optional)	155
Programming column pressure or flow	156
About Columns	153
Backflushing a Column	157
Backflushing when connected to an MS instrument	158
Nickel Catalyst Tube	164
About the nickel catalyst tube	164
Nickel catalyst gas flows	164
Setting temperatures for the nickel catalyst tube	165

About the Oven

Table 37 Oven capabilities

Capability	Range
Temperature range	–80 °C (liquid N ₂) or –40 °C (CO ₂) to the configured limit
Maximum temperature	450 °C
Temperature programming	Up to six ramps
Maximum run time	999.99 minutes
Temperature ramp rates	0 to 120 °C/min, depending on instrument configuration

Oven safety

For safety, opening the oven door turns off power to the oven heater, fan, and cryogenic valve (if installed) but maintains the setpoints in memory.

Closing the oven door returns the oven to normal operation.

If the oven cannot attain or maintain an entered setpoint temperature during normal above-ambient operation, a problem is assumed and the oven is switched off.

Possible problems include:

- The oven vent flaps not working
- The oven fan, heater, or temperature sensor not working properly
- An electronic problem

When a shutdown occurs, the **Off** line in the oven parameter list blinks and the oven remains off until switched on again by pressing **[Oven][On]** or by editing the **Temperature** setpoint.

Configuring the Oven

Oven configuration sets maximum temperature, equilibration time the cool down mode, and the cryogenic setpoints, if cryo is installed.

Maximum temperature Maximum allowable oven temperature setpoint. Some accessories, such as the valve box, valves and columns have specific temperature limits. When configuring **Maximum temperature**, these limits should be considered so that the accessories are not damaged. Oven setpoints are verified as they are entered; a message is displayed when an entered setpoint is inconsistent with a previously defined maximum.

Equilibration time The time required for the oven temperature to equilibrate after temperature is modified. Equilibration time begins when the actual oven temperature comes within 1 °C of the oven temperature setting. The **Equilibration time** setpoint can be 0 to 999.99 minutes.

Cryo See “Cryogenic Operation.”

External oven mode Press the GC **[Info]** key for details.

Slow oven cool down mode During the oven cooling period, the fan can operate at full speed or at a reduced speed. This parameter makes the choice.

Cryogenic Operation

The cryogenic valve lets you operate the oven below ambient temperature. Minimum attainable oven temperature depends on the type of valve installed.

The GC senses the presence and type of cryogenic valve and disallows setpoints if no valve is installed. When cryogenic cooling is not needed or cryogenic coolant is not available, the cryogenic operation should be turned off. If this is not done, proper oven temperature control may not be possible, particularly at temperatures near ambient.

Cryogenic setpoints

Equilibration time Set from 0 to 999.999 minutes.

Cryo [ON] enables cryogenic cooling, [OFF] disables it.

Quick cryo cool This is separate from **Cryo**. **Quick cryo cool** cools the oven faster after a run than it would without assistance. This is useful when maximum sample throughput is necessary, however it does use more coolant. **Quick cryo cool** turns off soon after the oven reaches its setpoint and **Cryo** takes over, if needed.

Ambient temp The temperature in the laboratory. This setpoint determines the temperature at which cryogenic cooling is enabled.

- Ambient temp + 25 °C, for regular cryo operation
- Ambient temp + 45 °C, for Quick Cryo Cool.

Cryo timeout Cryo timeout occurs, and the oven shuts off, when a run does not start within a specified time (10 to 120 minutes) after the oven equilibrates. Turning cryo timeout **Off** disables this feature. We recommend that it be turned **On** because cryo timeout conserves coolant at the end of a sequence or if automation fails.

Cryo fault Shuts the oven down if it does not reach setpoint temperature after 16 minutes of continuous cryo operation. Note that this is the time to *reach* the setpoint, not the time to stabilize and become ready at the setpoint. For example, with a cool on-column inlet and cryo control in the track oven mode, it may take the oven 20 to 30 minutes to achieve readiness.

If the temperature goes below the minimum allowed temperature ($-90\text{ }^{\circ}\text{C}$ for liquid nitrogen, $-70\text{ }^{\circ}\text{C}$ for liquid CO_2), the oven will shut down.

External oven mode Isothermal internal mode and programmed external oven used to calculate column flow.

Slow oven cool down mode **On** to run oven fan at slow speed during cool down.

About Oven Temperature Programming

You can program the oven temperature from an initial temperature to a final temperature using up to 20 ramps during a run.

A single ramp temperature program raises the initial oven temperature to a specified final temperature at a specified rate and holds at the final temperature for a specified period of time.

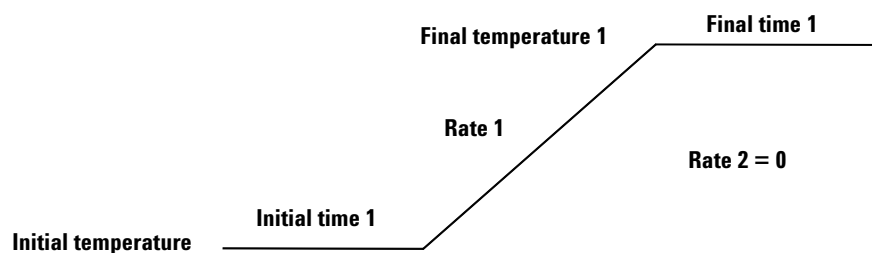

The multiple-ramp temperature program is similar. You can program the oven from an initial temperature to a final temperature, but with various rates, times, and temperatures in between. Multiple ramps can also be programmed for temperature *decreases* as well as increases.

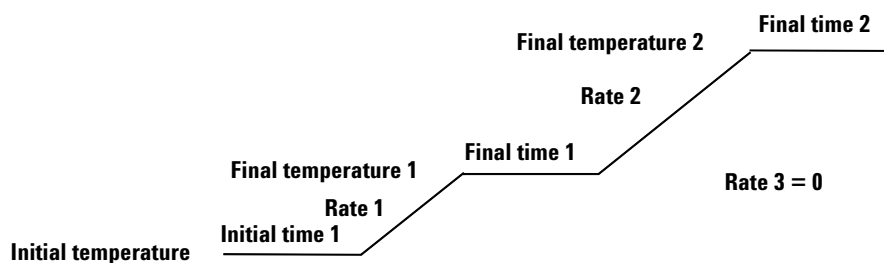

Programming setpoints

Temperature Starting temperature of a temperature programmed run. When the program begins, this value is copied into a temporary setpoint called **Init temp**. At the end of the run, **Temperature** is reset to the value in **Init temp** and the oven returns to its starting temperature.

Initial time Time in minutes that the oven will stay at the starting temperature after a programmed run has begun.

Rate The rate in °C/min at which the oven will be heated or cooled.

Final temperature Temperature of the oven at the end of a heating or cooling rate.

Final time Time in minutes that the oven will be held at the final temperature of a temperature-programmed rate.

Total length of a run is determined by its oven temperature program. The maximum allowable time for a run is 999.99 minutes. If the program is still running at that time, the run terminates.

See also “[Post Run Programming](#).”

Oven ramp rates

To use the fast oven ramp rates (a 240 V power option is required), your electric service must be able to supply ≥ 200 V at ≥ 15 Amp.

The highest rate that you can achieve depends on many factors, including the room temperature, temperatures of the inlets and detectors, the amount of material inside the oven (columns, valves, etc.), and whether or not this is the first run of the day.

The optional oven insert for fast chromatography (see “[About the Oven Insert](#)” on page 152), increases oven ramp rates for the back column. [Table 38](#) lists typical oven ramp rates.

Table 38 Oven ramp rates

Temperature range (°C)	100/120 V oven ramp rate (°C/minute)		200/220/230/240 V oven ramp rate (°C/minute)	
	Without insert	With optional insert	Without insert	With optional insert
50 to 70	75	120	120	120
70 to 115	45	95	95	120
115 to 175	40	65	65	110
175 to 300	30	45	45	80
300 to 450	20	35	35	65

Setting the oven parameters for constant temperature

An isothermal run is one in which the oven is maintained at a constant temperature. For an isothermal run, set **Rate 1** to zero.

- 1 Press [**Oven**] to open the oven parameter list.
- 2 Enter the oven temperature for the isothermal run.
- 3 Enter the number of minutes (**Initial time**) that you want the oven to stay at this temperature. This time is the duration of the run.
- 4 If **Rate 1** is not already **0**, enter zero for an isothermal run.

Setting the oven parameters for ramped temperature

Single ramp

- 1 Press [**Oven**] to open the oven parameter list.
- 2 Enter a starting temperature (**Temperature**).
- 3 Enter the time (**Initial time**) that you want the oven to stay at **Temperature**.
- 4 Enter the rate (**Rate 1**) at which the oven temperature is to change.
- 5 Enter the final temperature (**Final temperature 1**).
- 6 Enter the time (**Final time 1**) the oven is to hold **Final temperature 1**.
- 7 To end the oven ramp program after **Ramp 1**, set **Rate 2** to zero.

Multiple ramps

In a multiple-ramp program, **Final time** for one ramp is also **Initial time** for the next ramp. Thus, there is only one **Initial time**.

- 1 Set up the first oven ramp as described in “Single ramp”.
- 2 Enter the rate (**Rate 2**) at which you want the oven temperature to increase for the second oven ramp.
- 3 Enter the final temperature (**Final temperature 2**).
- 4 Enter the number of minutes (**Final time 2**) that you want the oven to hold the final temperature.
- 5 To end the temperature program after the second ramp, set **Rate 3** to zero.

- 6 To add additional oven ramps, repeat the steps described.

About the Oven Insert

The Oven Insert for Fast Chromatography reduces the oven volume so that the column and sample heat more quickly, yielding faster separation and faster chromatography. Furthermore, the smaller volume oven cools faster than a full-sized oven, reducing the overall analytical cycle time.

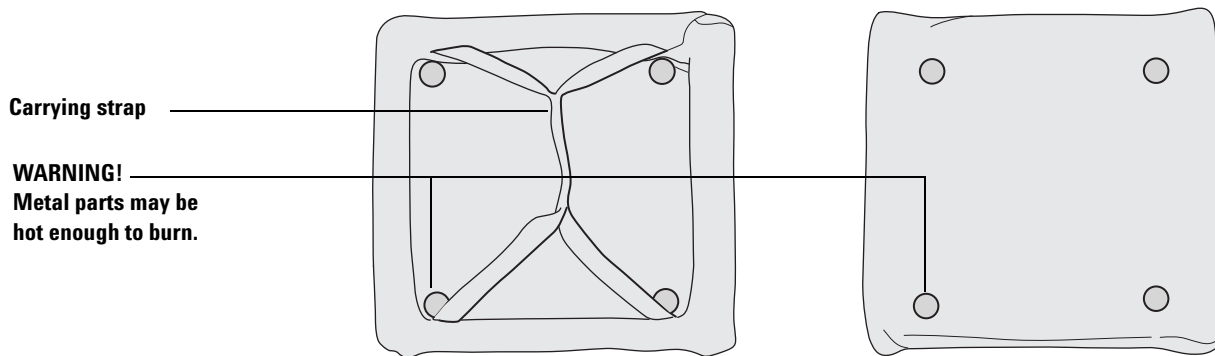

The oven insert is used with any inlet, column, and detector mounted in the **back** position. It is not compatible with any accessory which obstructs access to the front of the oven or which requires the use of either the front inlet or the front part of the oven.

About Columns

In all GCs, a sample—which is a mixture of several components—is vaporized in an inlet, separated in a column, and examined in a detector.

The column separates components in time because:

- When a vaporized component is presented with a gas phase and a coating phase, it divides between the two phases according to its relative attraction to the two phases.
- The “attraction” can be solubility, volatility, polarity, specific chemical interaction, or any other property that differs from one component to another.
- If one phase is stationary (the coating) and the other is moving (the carrier gas), the component will travel at a speed less than that of the moving phase. How much less depends on the strength of the attraction.
- If different components have different “attractions”, they will separate in time.

Selecting the correct packed glass column type

This topic is covered in the Maintenance manual. See [To attach a packed column to the purged packed inlet](#) for details.

About the column modes

The flow modes available are determined by the GC inlet’s control mode. When the inlet’s control mode is set to **Pressure control**, all of the flow modes and pressure modes below are available for the column. When the inlet’s control mode is set to **Flow control**, the column’s mode is not selectable. For an inlet’s mode of **Flow control**, only column flow can be entered.

The flow modes

Flow rates are corrected to NTP (normal temperature and pressure, 25 °C and 1 atmosphere).

- **Constant flow**—Maintains a constant mass flow rate of carrier gas in the column throughout the run. If the column resistance changes due to a temperature program, the column head pressure is adjusted to keep the flow rate constant. This can shorten runs significantly.
- **Ramped flow**—Increases the mass flow rate in the column during the run according to a program you enter. A column flow profile can have up to three ramps, each consisting of a programmed increase followed by a hold period.

The pressure modes

The pressure modes are not available if the column is not defined or the inlet's mode is set to **Flow control**.

Pressures are gauge pressures—the difference between the absolute pressure and the local atmospheric pressure. Because most detectors present little resistance to the column flow, the gauge pressure at the column head is usually the same as the pressure difference between column inlet and exit. The mass selective detector and the atomic emission detector are the exceptions.

- **Constant pressure**—Maintains a constant gauge pressure at the head of the column throughout the run. If the column resistance and gas density changes during a run, the gauge pressure does not change but the mass flow rate does.
- **Ramped pressure**—Increases the column head gauge pressure during the run according to a program you enter. A column pressure profile can have up to three ramps, each consisting of a programmed increase followed by a hold period.

Select a column mode

The column's mode parameter is not available if the inlet's mode parameter is set to **Flow control**.

When a splitter controlled by a PCM or AUX pressure is used to divide flow between multiple columns, only the mode setting of the lowest column number configured determines the mode used. All other column mode settings exiting the splitter are ignored by the GC.

- 1 Press **[Col 1]** or **[Col 2]**, or press **[Aux col #]** and enter the column number.
- 2 Scroll to the **Mode** line.

- 3 Press [**Mode/Type**] to see the column mode list.
- 4 Scroll to the column mode you want. Press [**Enter**].

This completes column mode selection. Next you must specify the inlet conditions either during the entire run (if you selected either of the constant modes) or at the beginning of the run (if you selected either of the ramped modes).

Setting the column parameters for constant flow or constant pressure

If the column is defined, you can enter any one of these quantities—the GC will calculate and display the other two.

For example, you may have selected **Constant pressure** as the column mode. You decide to specify, as a starting condition, the column flow. The GC will compute the pressure necessary to achieve this flow (as well as the average linear velocity) and hold this *pressure* constant during the run.

If you select **Constant flow** as the mode and specify column flow as the initial condition, the GC will still calculate the pressure necessary to achieve this flow, but it will adjust the pressure as necessary to maintain constant flow.

If the column is not defined, you can enter only pressure. Constant flow can still be specified, but the GC cannot know what the flow is.

- 1 Press [**Col 1**] or [**Col 2**], or press [**Aux col #**] and enter the column number.
- 2 Scroll to the **Pressure** or **Flow** or **Velocity** line.
- 3 Type the desired initial value, followed by [**Enter**]. The GC will compute and display the other two values. Adjust them, if you choose to, by repeating steps 2 and 3 but note that changing any one changes all three.

This completes setting the initial carrier gas condition.

Enter a flow or pressure program (optional)

If you selected either the ramped pressure or ramped flow column mode, the column parameter list contains entries for setting up a ramp program.

You begin with an initial value, either **Initial Pressure** or **Initial Flow**, and an **Initial time**. At the end of that time, **Rate 1** begins and runs until it reaches **Final pressure** (or **Final flow**). It

remains at that value for **Final time 1**. You can then add a second and third ramp, each consisting of a Rate, a Final value (pressure or flow), and a Final time.

The program ends when it reaches a **Rate** that is set to 0 (**Off**).

When a flow or pressure program is running, the **Pressure**, **Flow**, and **Velocity** lines that you used to set constant conditions show the progress of the program.

The oven program determines the length of the run. If a flow or pressure program ends before the analytical run does, the flow (or pressure) remains at the last final value.

Programming column pressure or flow

- 1 Press [**Col 1**] or [**Col 2**], or press [**Aux col #**] and enter the column number.
- 2 Scroll to **Initial pressure** (or **Initial flow**). Type the desired value and press [**Enter**].
- 3 Similarly, enter a value for **Initial time**. This completes the initial part of the program.
- 4 To begin a ramp, enter a positive value for **Rate 1**. It does not matter whether you are programming up or down—the rate is always positive.
- 5 If **Rate 1** is zero, the program ends here. If you enter any other value, the Final value lines for the first ramp appear and the cursor moves to the line.
- 6 Enter values for **Final pressure 1** (or **Final flow 1**) and **Final time 1**. This completes the first ramp.
- 7 To enter a second ramp, scroll to the appropriate **Rate** line and repeat steps 5 and 6. A maximum of 20 ramps can be entered.

Backflushing a Column

Backflush is a means of discarding high-boilers from a column after the peaks of interest have eluted. It saves analysis time and has these additional benefits:

- Longer column life
 - less high temperature exposure
 - removal of high-boilers
 - protection from air and water at high temperatures
- Less chemical background
 - ghost peaks
 - “wrap-around” of late eluters from previous runs
 - stationary phase decomposition peaks
- Less contamination of the mass selective detector (MS) source, if using MS
 - longer time between source cleanings
 - higher stability of calibrations

Agilent now provides two Backflush Wizard software utilities. One is available with the Instrument Utilities software, and the other is a component of your Agilent data system. These utilities complement each other, and automate the process of updating the GC and method to implement and validate successful backflushing. Contact your Agilent sales representative for more information.

The Instrument Utilities Backflush Wizard is available on the Agilent *GC and GC/MS User Manuals & Tools* DVD. The Backflush Wizard component for the data system is included in newer data systems, and is available as an add-on for older data systems from the *GC and GC/MS User Manuals & Tools* DVD.

If not using an Agilent Backflush Wizard, you will need to experimentally determine the correct flow/pressure settings and the backflush time appropriate for your analysis. Determine the correct values by testing the backflush method, then running a blank to check for residual late eluters.

CAUTION

Only backflush an inlet that has a split vent line with a chemical trap, such as the split/splitless, PTV, and VI. Attempts to backflush using other inlet types will most likely damage the pneumatics flow modules.

Refer to the Agilent web site at <http://www.agilent.com/chem> for example backflush applications, especially if using an MS or MSD.

Backflushing when connected to an MS instrument

If using an MS with the GC, backflushing becomes more complex. Install and use the optional Backflush Wizard available on the *GC and GC/MS User Manuals & Tools* DVD and in the Agilent data system.

Backflushing using a capillary flow technology device

Because the following capillary flow technology (CFT) devices connect to a controlled carrier gas supply, they can be used to backflush a column or pre-column:

- G2855B Capillary Flow Technology Deans Switching System (pre-column backflush)
- G3180B Capillary Flow Technology Two-Way Splitter (with makeup gas) (pre- or post-column backflush, depending on setup)
- G3183B Capillary Flow Technology Three-Way Splitter (pre- or post-column backflush, depending on setup)
- G3184B Optimized Tee (post-column)
- G3186B Purged Union or G1472A Pressure Controlled Tee (pre- or post-column backflush, depending on setup)
- G3486A Flow Modulator (post-column backflush)

A conceptual diagram for a post-column backflush setup is shown in the figure below.

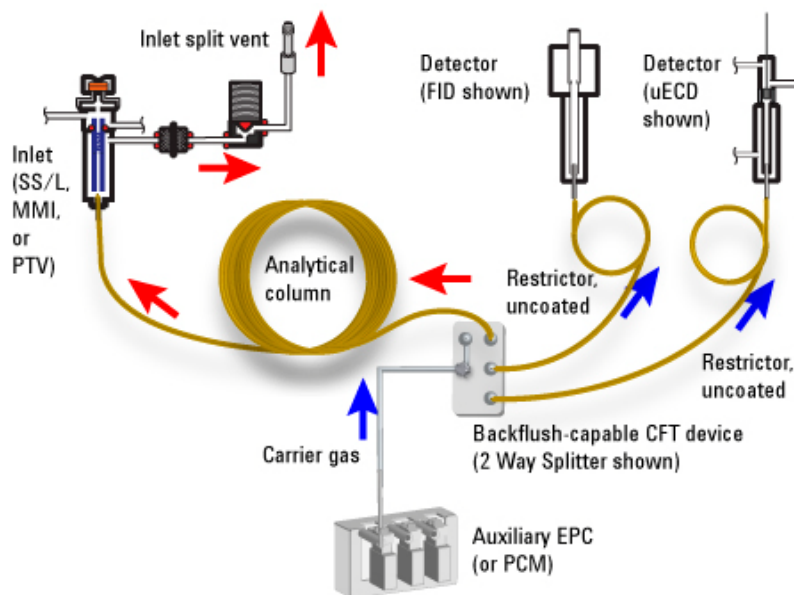

In the example shown above, after the last analyte of interest elutes on the analytical column, you can program a decrease in inlet column flow with an increase in the pressure/flow from the Aux EPC or PCM connected to the CFT device, thereby reversing column flow and forcing the remaining analytes off the column and out of the inlet split vent. You can do this using a post run program or as a ramped pressure or flow program.

Advantages of the optional Backflush Wizard

The procedures below provide simple ways to create the backflush program. However, for best results, use the optional Backflush Wizard. The wizard provides the following advantages:

- Helps you select the best technique for your setup.
- Helps you validate the hardware's capabilities for backflushing.
- Helps you create relevant baseline data (pre-backflush).
- Helps you validate that the backflushing worked (unwanted peaks are completely removed from the columns, while wanted peaks elute normally) by performing runs at various stages and analyzing the data.
- Helps you adjust the method, if needed, until the backflushing succeeds.

- Provides the ability to create pre-column backflush methods, which require careful adjustment due to the elution times and elution order differences found on pre-columns (compared to the analytical column).

For more information, see the *GC and GC/MS User Manuals & Tools* DVDs. In addition, the Backflush Wizard contains extensive documentation.

Procedures for manually creating a backflush method

To set up a post run backflush

A main advantage of the post-run backflush method is that the GC turns off detection during this time. If using an MS, this helps prevent damage to the detector and is the recommended backflush method.

If using an Agilent data system, a Backflush Wizard provides a straightforward interface for making these settings.

- 1 Verify that all columns are properly configured.
- 2 Since the backflush will run as a post-run program, set the method so that the oven program ends after the last peak of interest returns to baseline, or after reaching the last temperature of interest.
- 3 Press **[Post Run]** and enter the backflush duration as the **Time**.
 - The oven temperature and column pressure/flow setpoints for installed columns appear.
 - Whether you can enter a pressure or flow for a column depends on its mode (pressure or flow).
 - Some inlets, such as the multimode inlet, also provide a post run inlet temperature and total flow rate.
- 4 Enter the oven temperature for the backflush.
- 5 Enter the backflush flow(s) or pressure(s).

If in flow mode:

- Enter a negative flow for the column connected between the inlet and the CFT device. The GC will automatically establish the corresponding pressures needed in the inlet and the CFT device.
- Increase the flow rates in the column(s) connected between the CFT device and the detector(s).

If in pressure mode:

- Set the pressure of the column connected between the inlet and the CFT device to 0.000. This turns off flow from the inlet.
 - Increase the pressure of the primary column connected between the CFT device and the detector(s). This creates the backward flow through the column and increases the flow through any connected detectors.
- 6 If using a multimode inlet, enter a total flow and inlet temperature for the post run (backflush) period.

When developing the backflush portion of your method, consider the following:

- Ensure that the split vent flow setpoint is at least 25 mL/min and at least 50% more than the column backflush flow rate.
- If using gas saver, ensure that the gas saver flow setpoint is at least 25 mL/min and at least 50% more than the column backflush flow rate.

To backflush using a ramped pressure program

In this case, the backflush occurs as part of the run, so the detectors continue to collect data. During the backflush, you may wish to turn off data collection in the data system.

CAUTION

To avoid damage to an MS, Agilent strongly recommends setting up backflush as a post run event, not as part of a ramped column program. If you still choose to backflush as part of a run, be very careful that the flow into the MS does not exceed the limits of the vacuum pump.

- 1 Verify that all columns are properly configured.
- 2 Enter all method parameters for the analysis: sampler parameters, inlet parameters, oven temperature profile, detector flows and temperatures, and so forth.
- 3 Program the oven for the backflush.
 - Include any temperature profile needed for backflush.
 - Set the total run time to include sufficient time for backflush.
- 4 Program the pressure ramp for the column installed between the inlet and the CFT device. After the last analyte elutes or after reaching the last temperature of

interest, program a fast ramp (for example, 30 psi/min) with a final pressure of 0.

- 5 Program the pressure ramp for the primary column installed between the CFT device and the detector. The pressure should increase slightly during the backflush duration so that the flow into the detectors remains relatively stable.

If you turned off data acquisition in a data system during backflush, remember to turn it on again at the end of the run.

To backflush using a ramped flow program

In this case, the backflush occurs as part of the run, so the detectors continue to collect data. During the backflush, you may wish to turn off data collection in the data system.

CAUTION

To avoid damage to an MS, Agilent strongly recommends setting up backflush as a post run event, not as part of a ramped column program. If you still choose to backflush as part of a run, be very careful that the flow into the MS does not exceed the limits of the vacuum pump.

- 1 Verify that all columns are properly configured.
- 2 Enter all method parameters for the analysis: sampler parameters, inlet parameters, oven temperature profile, detector flows and temperatures, and so forth.
- 3 Program the oven for the backflush.
 - Include any temperature profile needed for backflush.
 - Set the total run time to include sufficient time for backflush.
- 4 Program the flow ramp for the column installed between the inlet and the CFT device. After the last analyte elutes or after reaching the last temperature of interest, program a fast ramp with a final flow that is negative.
- 5 Program the flow ramp for the primary column installed between the CFT device and the detector. Typically hold at the method's final value for the backflush duration.

If you turned off data acquisition in a data system during backflush, remember to turn it on again at the end of the run.

Backflushing using a switching valve

Backflushing is done using a column switching valve controlled by the Run Table. See “Run Time Programming” on page 12.

The valve is plumbed as follows:

- **Position 1** Carrier gas flows through the column to the detector. This is the normal flow path.
- **Position 2** Carrier gas flows through the column toward the inlet, removing components on the column through the inlet vent line.

The Run Table contains commands to perform these actions:

- After the last peak of interest appears, switch the valve to **Position 2**. Higher boiling peaks are discarded through the inlet vent.
- At the same time, turn data acquisition off.
- At the end of the backflush period (determined experimentally), switch the valve to **Position 1** and turn data acquisition on. The system is now ready for the next run.

Nickel Catalyst Tube

About the nickel catalyst tube

The Nickel Catalyst Tube accessory, G2747A, is used for trace analysis of CO and CO₂ with a flame ionization detector. The gas sample is separated on the column and passed over a heated catalyst in the presence of hydrogen, which converts the CO and CO₂ peaks to CH₄.

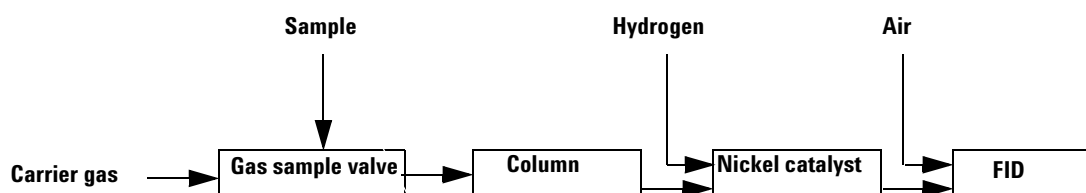

Nickel catalyst gas flows

For a standard FID installation:

Table 39 Gas flows for a standard FID

Gas	Flow rate, mL/min
Carrier (helium)	30
FID hydrogen	30 (see Caution)
FID air	400

Table 40 Gas flows for a TCD/FID series installation

Gas	Flow rate, mL/min
Carrier (helium)	30
TCD switching flow	25
FID hydrogen	45 (see Caution)
FID air	500

CAUTION

Hydrogen flow is pressure-controlled, where an FID provides a known resistance. The nickel catalyst tube increases flow resistance, so that the calibration is no longer valid. You must measure hydrogen flow with a bubble or similar meter.

The nickel catalyst can be damaged by exposure to air.

Setting temperatures for the nickel catalyst tube

The nickel catalyst tube is usually mounted in the back inlet position and controlled by the back inlet temperature setpoint. For most analyses, set these temperatures:

- Nickel catalyst tube—375 °C
- FID—400 °C

Hydrogen Sensor

The Hydrogen Sensor module checks for uncombusted free hydrogen in the GC column oven. During normal operation with hydrogen as a carrier gas, leaks from the inlets or detectors could possibly put hydrogen gas directly into the oven. Hydrogen-air mixtures are potentially explosive in concentrations of 4–74.2% hydrogen by volume. The sensor monitors the free hydrogen level in the oven and will trigger a shutdown of all hydrogen gas flows if the hydrogen level in the oven is > 1%.

In the event of a hydrogen safety shutdown, the GC records the event in its Event log.

See the *Troubleshooting* manual for more information about GC shutdown events and how to clear them.

The GC can only shut down hydrogen gas flows that have been configured properly. Always configure the gas types used for the inlets, detectors, and so forth.

Instrument logs

The GC will log the following hydrogen sensor events in its event logs:

- Hydrogen safety shutdowns initiated by the hydrogen sensor
- Calibrations
- Hydrogen sensor tests

Calibration

The hydrogen sensor requires periodic calibration for optimal performance. See the Operation Manual for details. If the sensor is not calibrated on schedule or if a calibration fails for any reason (for example, a lack of calibration gas), the sensor continues to use its existing calibration data.

Status information

By default, the hydrogen sensor current reading (in percent) appears in the GC status display.

If a calibration fails, the GC's Service Due indicator lights. Press [**Service Mode**] on the GC keypad. The first line will indicate that the hydrogen sensor calibration failed.

Operation with an Agilent data system

Using the hydrogen sensor with an Agilent data system provides additional features. Use the data system to:

- Print calibration reports. The report includes a plot of all calibration data stored in the GC,
- Access the automated calibration schedule control (on/off).
- Store lot number and expiration date information for the calibration gas cylinder.
- View the hydrogen sensor status information in the GC status user interface. The status shows the current percent hydrogen level and any messages related to the hydrogen sensor.
- Plot the measured hydrogen level as a diagnostic signal, if desired.
- View and print all logged entries for calibrations, cylinder information, and shutdowns.

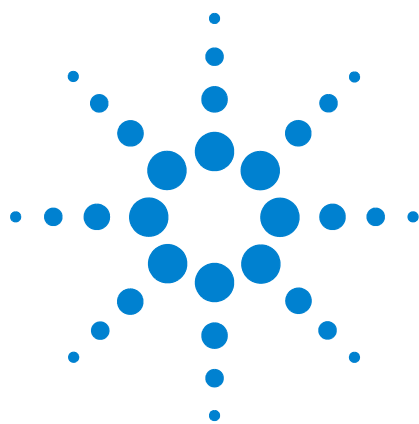

5 Detectors

About Makeup Gas 170

About the FID 171

About the TCD 176

About the uECD 184

About the NPD 190

About the FPD+ 202

About the FPD 209



About Makeup Gas

Most detectors use a makeup gas to increase the flow rate through the detector body. This sweeps peaks out of the detector quickly, avoiding mixing of components and loss of resolution. This is particularly important with capillary columns because the column flow rates are so small.

The makeup gas line of your detector parameter list changes depending on your instrument configuration.

If you have an inlet with the *column not defined*, the makeup flow is constant. If you are operating with *column defined*, you have a choice of two makeup gas modes.

Constant makeup This mode provides a constant flow of makeup gas to the detector.

Column + makeup = constant This mode provides a variable flow of makeup gas to the detector. As column flow increases or decreases, the makeup flow changes to provide a constant combined flow to the detector. If you choose this option, enter a value under **Combined flow**. The **Combined flow** line always displays the same value, while the **Makeup** line changes as the actual makeup flow changes.

To change the makeup gas flow mode

- 1 Press **[Front Det]** or **[Back Det]**.
- 2 Scroll to **Mode**. Press **[Mode/Type]**.
- 3 Scroll to the correct mode and press **[Enter]**.

About the FID

The FID passes sample and carrier gas from the column through a hydrogen-air flame. The hydrogen-air flame alone creates few ions, but burning an organic compound increases the number of ions produced. A polarizing voltage attracts these ions to a collector located near the flame. The current produced is proportional to the amount of sample being burned. This current is sensed by an electrometer, converted to digital form, and sent to an output device.

The FID uses three supply gases (hydrogen, makeup gas, and air) and two supply lines. Air flows through one supply line, while hydrogen mixed with the makeup gas flows through the other. All three supply gases use:

- A filter frit to protect the flow path and limit the flow rate
- A proportional valve to control the pressure
- A pressure sensor and restrictor to control the valve

The hydrogen and makeup mix outside the flow module and enter the detector at the base of the jet. Air enters above the jet.

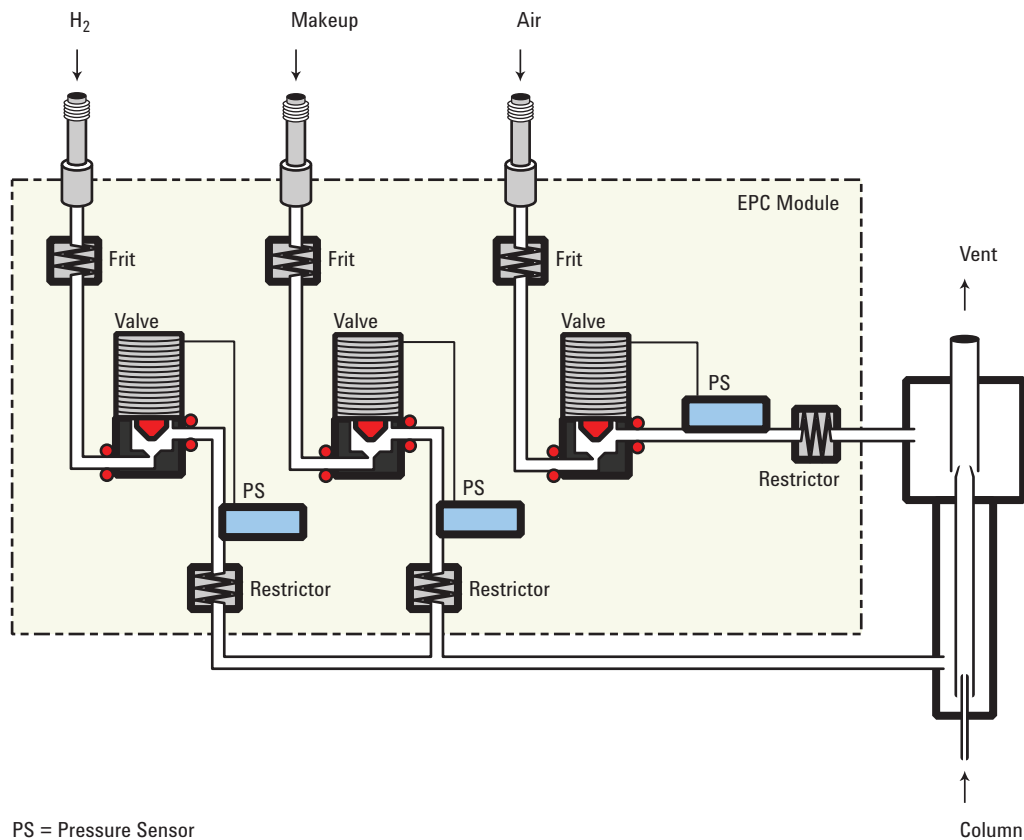
**Table 41** Properties of the FID

Property	Value/Comment
Dynamic range	1×10^7
Sensitivity	10 to 100 picograms of an organic compound dependent on the molecular structure.
Selectivity	Responds to all organic compounds (C-H bonds) except those which do not burn or ionize in the hydrogen-air flame. There is little or no response for H ₂ O, CO ₂ , CO, N ₂ , O ₂ , CS ₂ or inert gases. Formaldehyde and heavily halogenated compounds give minimal response.

How FID units are displayed in Agilent data systems and on the GC

The GC displays the FID signal in picoamperes (pA). The following table lists how different data systems convert the display units to reporting units.

Table 42 Unit conversions

Data system	Height units	LSV (height units)	Area units	Noise (ASTM) [‡]
Agilent data system	1 pA	1.3×10^{-4} pA	1 pA-sec	0.038 pA
SIGRange [†] 0	1×10^{-4} pA	1.3×10^{-4} pA	1×10^{-4} pA	0.038 pA
SIGRange 5	3.2×10^{-3} pA	4.2×10^{-3} pA	3.2×10^{-3} pA	0.038 pA
Analog 1V [‡]	1.25×10^{-4} pA	device dependent	1.25×10^{-4} pA	0.038 pA

* Noise is recommended maximum when determining MDL.

† SIGRange used with 3393 and 3396 integrators.

‡ Analog 1V is an approximate value.

To light the FID flame

Press [**Front Det**] or [**Back Det**], scroll to **Flame**, then press [**On/Yes**].

To extinguish the FID flame

Press [**Front Det**] or [**Back Det**], scroll to **Flame**, then press [**Off/No**].

FID automatic reignition (Lit offset)

Lit offset is the expected minimum difference between the FID output with the flame lit and the output with the flame off. The GC checks this value during runs and when loading a method.

During a run, if the output falls below the **Lit offset** value, the FID will attempt to reignite three times. If after the third attempt the output does not increase by at least this value, the detector shuts down all functions except temperature and makeup gas flow.

When loading a method that includes a **Flame On** setting, the GC performs a similar check. If the detector output is less than the **Lit offset**, it will attempt reignition after reaching method setpoints.

The default setting for **Lit offset** is 2.0 picoamps. This is a good working value for all but very clean gases and systems. You may want to lower this setpoint if the detector attempts to reignite when the flame is still on, thus producing a shutdown.

To change **Lit offset**:

- 1 Press **[Config][Front Det]** or **[Config][Back Det]**.
- 2 Scroll to **Lit offset**.
- 3 Enter the new value and press **[Enter]**.

Recommended starting conditions for new FID methods

See [Table 43](#) for guidelines and rules to select initial detector settings for new methods.

Table 43 Recommended starting conditions

Combustible gas mix	Make sure that the final hydrogen-to-air ratio is between 8% and 12%	
Detector temperature	Set to 20 °C above the highest oven temperature, depending on the column type.	
	A temperature of 300 °C provides a good starting point and easier ignition, and minimizes water condensation.	
	The GC will not attempt to ignite the flame at a temperature <150 °C.	
Carrier gas flow (hydrogen, helium, nitrogen)		
Packed columns	Suggest 10 to 60 mL/min	
Capillary columns	Suggest 1 to 5 mL/min	
Detector gases	Flow range mL/min	Suggested flow mL/min
Standard installation		
Column plus capillary makeup	10 to 60	30
Hydrogen	24 to 60	30
Air	200 to 600	400
With Nickel Catalyst Accessory: Standard installation		
Column plus capillary makeup	10 to 60	30
Hydrogen	24 to 60	30*
Air	200 to 600	400
With Nickel Catalyst Accessory: TCD to FID series installation		
Column plus capillary makeup	10 to 60	30
TCD switching flow		25
Hydrogen	24 to 60	45*

Table 43 Recommended starting conditions (continued)

Air	200 to 600	450
-----	------------	-----

* Detector hydrogen is pressure controlled, where the detector provides a known resistance. If using a nickel catalyst tube, the resistance changes, and the flow rates displayed by the GC will not be accurate. Measure the actual hydrogen flow using a flow meter at the detector vent, with all other flows turned off.

Use nitrogen makeup gas (instead of helium) for greater sensitivity.

Setting parameters for FID

WARNING

Verify that a column is installed or the FID column fitting is plugged before turning on the air or hydrogen. An explosion may occur if air and hydrogen are allowed to leak into the oven.

To set the FID parameters:

- 1 Verify:
 - Makeup gas is configured
 - Installed jet type is correct for column type
- 2 Press **[Front Det]** or **[Back Det]**.
- 3 Set the detector temperature. The temperature must be greater than 150 °C for the flame to light.
- 4 Set the hydrogen flow rate, if desired, and press **[Off/No]**.
- 5 Change the air flow rate, if desired, and press **[Off/No]**.
- 6 If using a packed column, set the FID makeup gas to **0.0/Off**.
- 7 If using a defined capillary column, set the makeup gas flow or combined column plus makeup gas flow.
- 8 Scroll to **Flame** and press **[On/Yes]**. This turns on the air and hydrogen and initiates the ignition sequence. The signal typically increases to 5 to 20 pA after ignition.

Verify that the flame is lit by holding a cold, shiny surface, such as a mirror or chrome-plated wrench, over the collector exit. Steady condensation indicates that the flame is lit.

About the TCD

The TCD compares the thermal conductivities of two gas flows—pure carrier gas (the reference gas) and carrier gas plus sample components (the column effluent).

This detector contains a filament that is heated electrically so that it is hotter than the detector body. The filament temperature is held constant while alternate streams of reference gas and column effluent pass over it. When a sample component appears in the effluent, the power required to keep the filament temperature constant changes. The two gas streams are switched over the filament five times per second (hence the ticking sound) and the power differences are measured and recorded.

When helium (or hydrogen) is used as carrier gas, the sample causes the thermal conductivity to fall. If nitrogen is used, the thermal conductivity usually goes up because most things are more conductive than nitrogen.

Because the TCD does not destroy the sample during the detection process, this detector can be connected in series to a flame ionization detector or other detector.

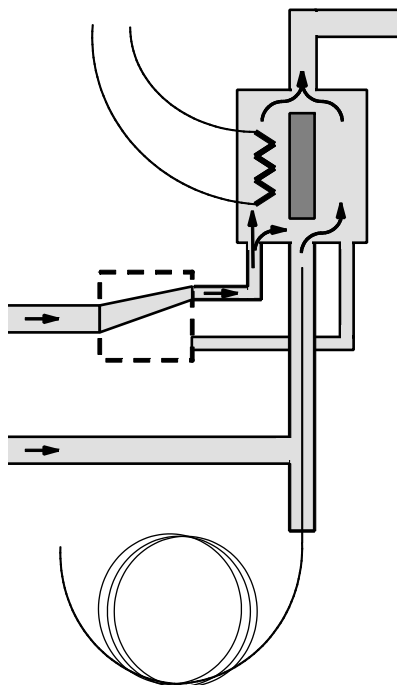

Column effluent is forced away from the filament. TCD measures reference gas.

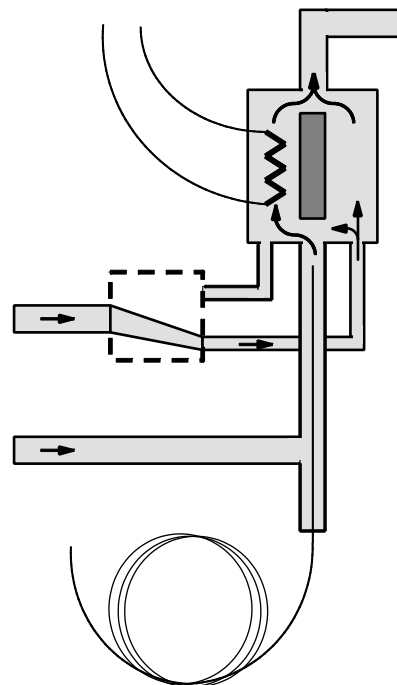

Column effluent is forced toward the filament. TCD measures peaks (if present).

TCD pneumatics

The figure below shows the pneumatics design of the TCD.

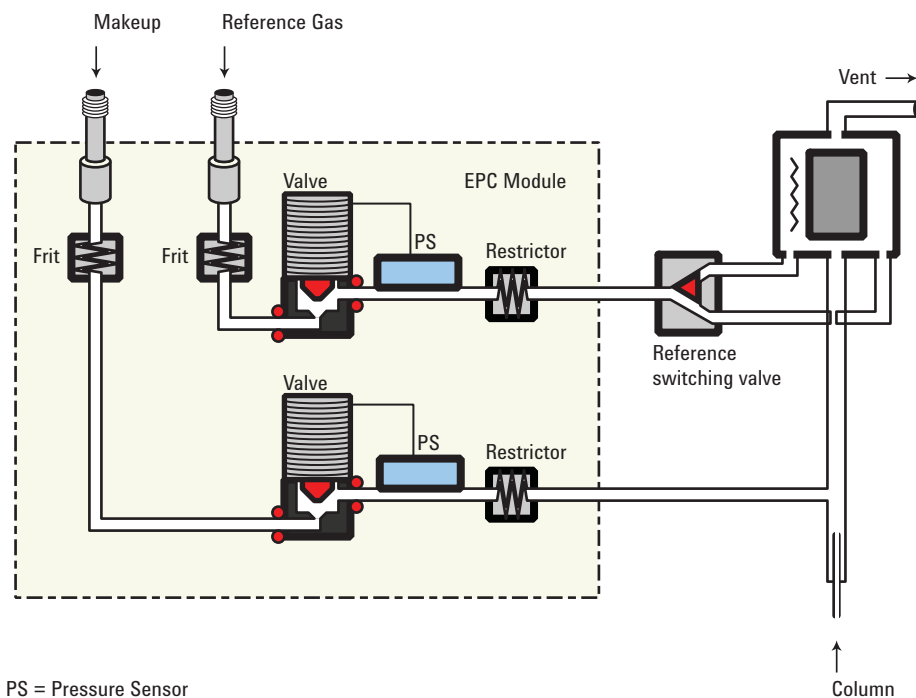

TCD carrier, reference, and makeup gas

Reference and makeup gas must be the same as the carrier gas, and the gas type must be specified in both the inlet and detector parameter lists.

When using packed columns, we recommend a small makeup gas flow (2 to 3 mL/min) to get the best peak shapes.

Use the next figure to select a value for reference gas flow for either capillary or packed columns. Any ratio within ± 0.25 of that in the figure is suitable.

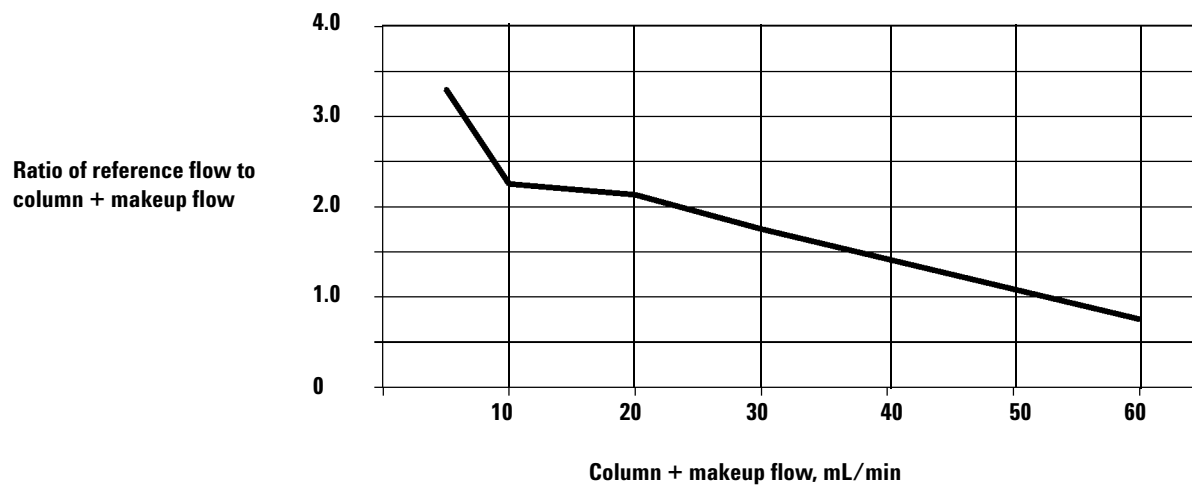

TCD gas pressures

Choose a flow, find a pressure, set source pressure 10 psi (70 kPa) higher.

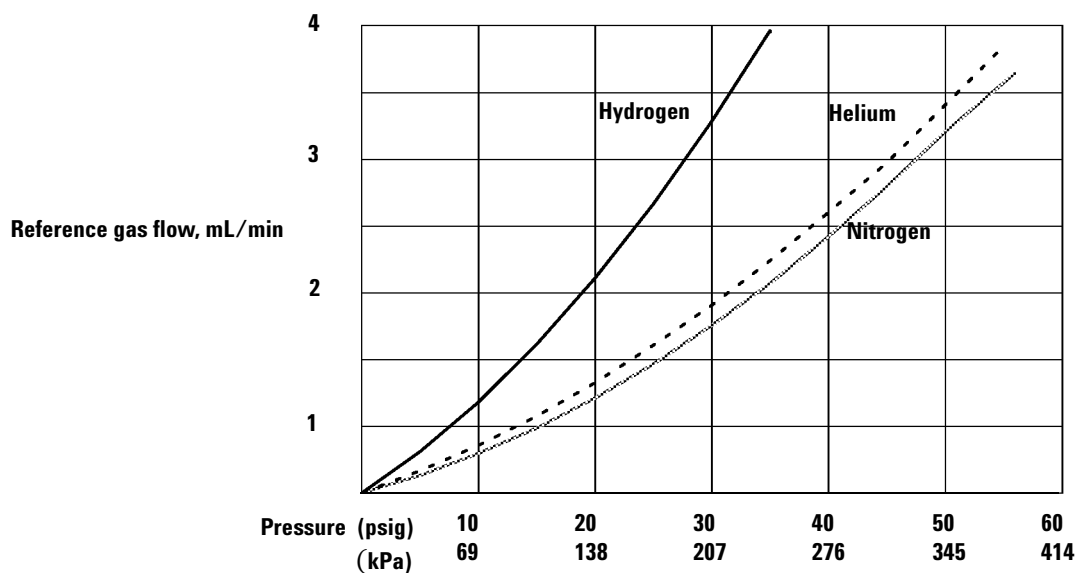

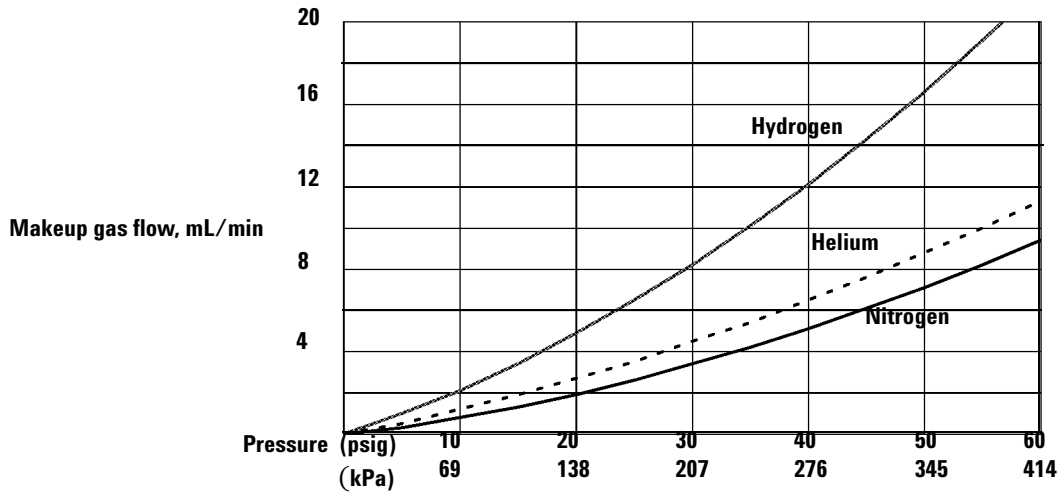

Selecting reference and makeup flows for the TCD

Table 44 Recommended flow rates and temperatures

Gas type	Flow range
Carrier gas <i>(hydrogen, helium, nitrogen)</i>	Packed, 10 to 60 mL/min Capillary, 1 to 5 mL/min
Reference <i>(same gas type as carrier)</i>	15 to 60 mL/min See the figures to select a value.
Capillary makeup <i>(same gas type as carrier)</i>	5 to 15 mL/min—capillary columns 2 to 3 mL/min—packed columns
Detector temperature	
<150 °C, cannot turn on filament	
Detector temperature should be 30 °C to 50 °C greater than highest oven ramp temperature.	

Sample components with higher thermal conductivities than the carrier gas produce negative peaks. For example, helium or hydrogen form a negative peak with nitrogen or argon-methane as the carrier gas.

Chemically active compounds reduce TCD filament life

The tungsten-rhenium TCD filament has been chemically passivated to protect against oxygen damage. However, chemically active compounds such as acids and halogenated

compounds may attack the filament. The immediate symptom is a permanent change in detector sensitivity due to a change in filament resistance.

If possible, such compounds should be avoided. If this is not possible, the filament may have to be replaced frequently.

Changing the TCD polarity during a run

Negative polarity On inverts the peak so the integrator or Agilent data system can measure it. **Negative polarity** can be a run table entry; see [“Run Time Programming”](#) on page 12.

Detecting hydrogen with the TCD using helium carrier gas

Hydrogen is the only element with thermal conductivity greater than helium, and mixtures of small amounts of hydrogen (<20%) in helium at moderate temperatures exhibit thermal conductivities less than either component alone. If you are analyzing for hydrogen with helium carrier gas, a hydrogen peak may appear as positive, negative, or as a split peak.

There are two solutions to this problem:

- Use nitrogen or argon-methane as carrier gas. This eliminates problems inherent with using helium as carrier, but causes reduced sensitivity to components other than hydrogen.
- Operate the detector at higher temperatures—from 200 °C to 300 °C.

You can find the correct detector operating temperature by analyzing a known range of hydrogen concentrations, increasing the operating temperature until the hydrogen peak exhibits normal shape and is always in the same direction (negative relative to normal response to air or propane) regardless of concentration. This temperature also ensures high sensitivity and linear dynamic range.

Because hydrogen peaks are negative, you must turn negative polarity on at appropriate times so the peak appears positive.

Setting parameters for the TCD

- 1 Press [**Front Det**] or [**Back Det**].
- 2 Set the detector temperature. Do not set higher than the maximum temperature allowed for the column because part of the column passes through the heated block and into the cell.
- 3 Verify that makeup gas type is the same as that plumbed to your instrument (next to **Makeup** line in the parameter list). Change the gas type, if necessary.
- 4 Set the reference gas flow rate.
- 5 If you are using packed columns, turn off the makeup gas (or proceed to step 6 and enter 2 to 3 mL/min, see “[TCD carrier, reference, and makeup gas](#)” on page 178) and proceed to step 7
- 6 If you are using *capillary columns*, choose a flow mode and set the makeup gas flow or combined flow.
- 7 Turn on the filament. Allow about 30 minutes for thermal stabilization. A longer period may be needed for the highest sensitivity.
- 8 If necessary, turn **Negative polarity [On/Yes]** to invert negative-going peaks. When a sample contains components giving both positive- and negative-going peaks, **Negative polarity** can be switched on and off during a run as a timetable event.

Example: Packed mode (packed and large capillary columns)

Column flow is 15 to 60 mL/min. Set the reference flow to 1.5 times the sum of column flow + makeup flow.

Makeup gas is recommended with all capillary columns. It allows the column to be inserted all the way into the detector and withdrawn 1 mm. If makeup is not used, the column must be no more than 3 mm above the ferrule. Minimum makeup flow is 1 mL/min.

1/8-inch stainless steel column If column flow is 30 mL/min, set the reference flow to $30 \times 1.5 = 45$ mL/min. Total detector flow is $30 + 45 = 75$ mL/min.

10 m × 0.53 mm column If column flow is 15 mL/min and makeup flow = 2 mL/min, set the reference flow to $1.5 \times (15 + 2) = 25.5$ mL/min. Total detector flow is $15 + 25.5 = 40.5$ mL/min.

Example: Capillary mode (small capillary columns)

If combined column plus makeup flow is between 5 and 10 mL/min, set the reference flow at 3× the combined flow. For a combined flow between 10 and 15 mL/min, use a multiplier of 2. This will bring the TCD within 25% of the maximum response. For further optimization, adjust the reference flow.

2 m × 0.2 mm capillary column If column flow is 0.75 mL/min, the makeup must be at least 4.25 mL/min. Set it = 5. Reference flow will then be $3 \times 5.75 = 17.25$ mL/min. Total detector flow = $5.75 + 17.25 = 22.5$ mL/min.

25 m × 0.32 mm capillary column If column flow = 10 mL/min, set makeup low to minimize sample dilution. Set it = 2 mL/min. Reference flow will then be $12 \times 2 = 24$ mL/min. Total detector flow = $12 + 24 = 36$ mL/min.

About the uECD

The micro-cell detector (uECD) contains a cell plated with ^{63}Ni , a radioactive isotope. The ^{63}Ni releases β particles that collide with carrier gas molecules to produce low-energy electrons—each β particle produces approximately 100 electrons. The free electrons produce a small current—called the *reference* or *standing current*—that is collected and measured in a pulsed circuit.

When a sample component molecule comes into contact with the free electrons, the electrons may be captured by the sample molecules to create negatively charged ions. The voltage across the cell electrodes is pulsed to collect the remaining free electrons while the heavier ions are relatively unaffected and swept out the vent with the carrier gas flow.

Cell current is measured and compared to a reference current. The pulse rate is adjusted to maintain a constant cell current. The more uncaptured electrons, the lower the pulse frequency required to match the reference current. When a component that captures electrons passes through the cell, the pulse rate rises. This pulse rate is converted to a voltage and recorded.

uECD safety and regulatory information

The ^{63}Ni isotope

The radioactive isotope used in the cell is ^{63}Ni . It is plated onto the inner surface of the cell body and is solid at temperatures used in chromatography. Some other properties are listed below.

Table 45 Properties of ^{63}Ni

Property	Value
Half-life:	101.1 years
Emission:	65.87 keV max., beta radiation
Melting point:	1453 °C
Dimensions of the active part of the uECD:	Inside diameter: 6 mm Height: 4.2 mm
Total activity (uECD cell):	555 MBq (15 millicuries) maximum

uECD licenses

Customers in the United States can purchase an exempt model uECD. Customers outside the United States should contact their local Agilent sales office for information.

uECD warnings

Although beta particles at this energy level have little penetrating power—the surface layer of the skin or a few sheets of paper will stop most of them—they may be hazardous if the isotope is ingested or inhaled. For this reason the cell must be handled with care: Radioactive leak tests must be performed at the required intervals (not applicable to exempt models), the inlet and outlet fittings must be capped when the detector is not in use, corrosive chemicals must not be introduced into the detector, and the effluent from the detector must be vented outside the laboratory environment.

WARNING

Materials that may react with the ^{63}Ni source, either to form volatile products or to cause physical degradation of the plated film, must be avoided. These materials include oxidizing compounds, acids, wet halogens, wet nitric acid, ammonium hydroxide, hydrogen sulfide, PCBs, and carbon monoxide. This list is not exhaustive but indicates the kinds of compounds that may cause damage to ^{63}Ni detectors.

WARNING

In the *extremely unlikely* event that *both* the oven *and* the detector heated zone should go into thermal runaway (maximum, uncontrolled heating in excess of 400 °C) at the *same time*, and that the detector remains exposed to this condition for *more than 12 hours*, take the following steps:

- After turning off the main power and allowing the instrument to cool, cap the detector inlet and exhaust vent openings. Wear disposable plastic gloves and observe normal laboratory safety precautions.
- Return the cell for exchange, following directions included with the License Verification Form (part no. 19233-90750).

- Include a letter stating the condition of abuse.

It is unlikely, even in this very unusual situation, that radioactive material will escape the cell. However, permanent damage to the ^{63}Ni plating within the cell is possible, and therefore, the cell must be returned for exchange.

WARNING

Do not use solvents to clean the uECD.

WARNING

You may not open the uECD cell unless authorized to do so by your local nuclear regulatory agency. Do not disturb the four socket-head bolts. These hold the cell halves together. United States customers removing or disturbing them is a violation of the terms of the exemption and could create a safety hazard.

Safety precautions when handling uECDs

- Never eat, drink, or smoke when handling uECDs.
- Always wear safety glasses when working with or near open uECDs.
- Wear protective clothing such as laboratory jackets, safety glasses, and gloves, and follow good laboratory practices. Wash hands thoroughly with a mild non-abrasive cleaner after handling uECDs.
- Cap the inlet and outlet fittings when the uECD is not in use.
- Connect the uECD exhaust vent to a fume hood or vent it to the outside. See the latest revision of title 10, Code of Federal Regulations, part 20, (including appendix B) or the applicable State regulation. For other countries, consult with the appropriate agency for equivalent requirements.

Agilent Technologies recommends a vent line inside diameter of 6 mm (1/4 inch) or greater. With a line of this diameter, the length is not critical.

uECD gas flows

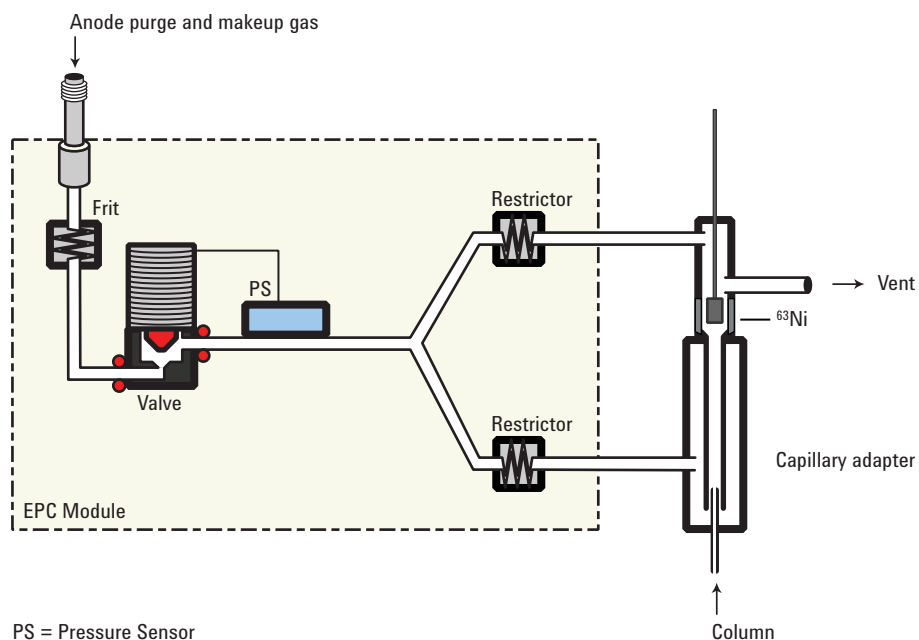

uECD linearity

The uECD response factor versus concentration curve is linear for four orders of magnitude or more (linear dynamic range = 10^4 or higher) for a broad range of compounds. You should still run a calibration curve on your samples to find the limits of the linear range for your materials.

uECD detector gas

The uECD operates with either nitrogen or argon/methane as the makeup and anode gas. Purity is critical; gases must exceed 99.9995% purity.

Because of the high detector sensitivity, carrier and makeup gas must be dry and oxygen-free. Moisture, chemical, and oxygen traps in good condition should be installed in carrier and makeup gas supply lines. Do not use plastic (including PTFE) tubing, plastic-bodied traps, or O-ring seals.

uECD temperature

To prevent peak tailing and to keep the cell clean, the detector temperature should be set higher than the highest oven temperature used—the setpoint should be based on the

elution temperature of the last compound. If you operate at excessively high temperatures, your results will not necessarily improve and you may increase sample and column decomposition.

uECD analog output

If you intend to use the analog output from the uECD, you must set the output Range to 10.

- 1 Press **[Analog Out 1]** or **[Analog Out 2]**.
- 2 Scroll to **Range**.
- 3 Type **10** and press **[Enter]**.

Recommended starting conditions for new uECD methods

Use the following information when selecting temperatures and flows. Maximum source pressure must not exceed 100 psi. Use the maximum source pressure to achieve maximum makeup flow rate.

Table 46 Starting values

Gas	Recommended flow range
Carrier gas	
Packed columns (nitrogen or argon-methane)	30 to 60 mL/min
Capillary columns (hydrogen, nitrogen, or argon-methane)	0.1 to 20 mL/min, depending on diameter
Capillary makeup (nitrogen or argon-methane)	10 to 150 mL/min (30 to 60 mL/min typical)
Temperature	
250 °C to 400 °C	
Detector temperature is typically set 25 °C greater than the highest oven ramp temperature.	

uECD makeup gas notes

If the carrier gas type is different from the makeup gas type, the makeup gas flow rate must be at least three times the carrier gas flow rate.

uECD sensitivity can be increased by reducing the makeup gas flow rate.

uECD chromatographic speed (for fast peaks) can be increased by increasing the makeup gas flow rate.

uECD temperature programming

The uECD is flow sensitive. If you are using temperature programming, in which the column flow resistance changes with temperature, set up the instrument as follows:

- Set the carrier gas in the **Constant flow** mode. Set detector makeup gas to **Constant makeup**.
- If you choose to work in the constant pressure mode, the makeup gas should be set in the **Column +makeup=constant** mode.

Setting parameters for the uECD

Verify that your detector gases are connected, a column is properly installed, and the system is free of leaks. Set the oven temperature and the inlet temperature and flow. Make sure your carrier gas type is the same as that plumbed to your GC.

- 1 Press [**Front Det**] or [**Back Det**].
- 2 Set the detector temperature. To keep the uECD cell clean, this temperature must be higher than the oven temperature.
- 3 Verify that the makeup gas type is the same as that plumbed to your instrument. The gas type is in parentheses next to the **Makeup** line on the parameter list. Change the gas type, if necessary.
- 4 Enter a value for the makeup gas flow.
 - If you are using *packed columns*, turn off the makeup gas.
 - If your *capillary column* is *defined*, choose a flow mode and set the makeup or combined gas flow.
 - If your *capillary column* is *not defined*, only constant makeup flow is available. Enter a makeup gas flow.

About the NPD

New NPD features and changes

The NPD firmware in this GC (A.01.08 or higher) is considerably different from that in earlier versions and from the 6890 firmware. Major changes are:

- Equilibration time parameter has been removed.
- Adjust Offset feature has been changed.
- Auto Adjust on/off has been added.
- Dry Mode has been added.
- Blos/ceramic bead selector has been added.

We strongly recommend that you allow the firmware to perform Auto Adjust and set the Bead Voltage.

NPD software requirements

This discussion assumes that the following firmware/software is installed:

Table 47 Software requirements

Product	Software/firmware revision
7890B or 7890A+ GC	All
7890A GC	A.01.08 or higher
Agilent OpenLAB CDS	All
Agilent MassHunter WorkStation	All
Agilent GC ChemStation	B.04.01 or higher
Agilent MSD ChemStation	G1701EA or higher
Agilent EZ Chrom Elite	3.3.2 or higher

Software/firmware with numbers less than shown in the table can cause reduced bead lifetime. See the Agilent web site (www.agilent.com) for firmware and software updates.

NPD flows and general information

The NPD passes sample and carrier through a hydrogen/air plasma. A heated ceramic or glass source, called the bead, is just above the jet. The low hydrogen/air ratio cannot sustain a flame,

minimizing hydrocarbon ionization, while the alkali ions on the bead surface facilitate ionization of nitrogen- or phosphorus-organic compounds. The output current is proportional to the number of ions collected. It is sensed by an electrometer, converted to digital form, and sent to an output device.

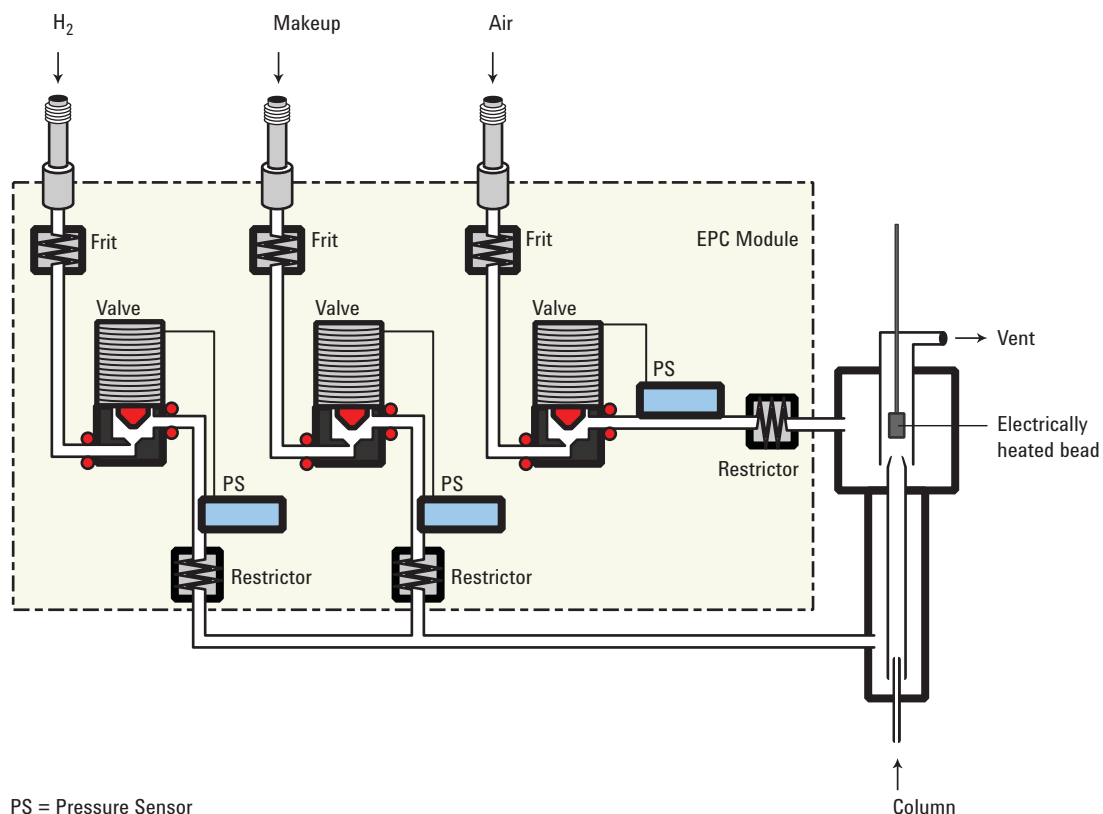

NPD flow, temperature, and bead recommendations

Table 48 General operating values

Gas or Setting	Recommendation
Carrier gas (helium, hydrogen, nitrogen)	Capillary, choose optimum flow based on column dimensions.
Detector gases	
Hydrogen	Ceramic bead 2 to 5 mL/min Bios bead 1 to 3 mL/min
Air	60 mL/min

Table 48 General operating values (continued)

Gas or Setting	Recommendation
Capillary makeup (<i>helium, nitrogen</i>)	Ceramic bead Nitrogen: 5 to 10 mL/min Helium: less than 5 mL/min Bios bead 1 to 20 mL/min
Temperature	
Default is 250 °C; operating range is 150 °C to 400 °C.	
<ul style="list-style-type: none"> • <150 °C, the Adjust offset process will not start. • 325 to 335 °C is recommended. • Detector temperature should be greater than the highest oven temperature. With higher detector temperatures, less bead heating voltage is required. 	
Adjust offset	
Default is 30 pA, suggested operating range is 20 to 40 pA, and allowable range is 0 to 99.9 pA.	
<ul style="list-style-type: none"> • ≥ 50 pA increases sensitivity but reduces bead life. • Lower settings reduce sensitivity and increase bead life, but settings too low will result in solvent quenching. • The time required for Adjust offset depends on the bead type and condition. 	
Bead voltage	
Ceramic bead. Range is 0 to 4.095 V.	
Bios bead. Range is 0.5 to 1.1 V.	
<ul style="list-style-type: none"> • Use Auto Adjust On, Dry Bead, and let the GC set the Bead Voltage for you. 	

Source gas pressures

Choose a flow, find a pressure, and set source pressure 10 psi (70 kPa) higher.

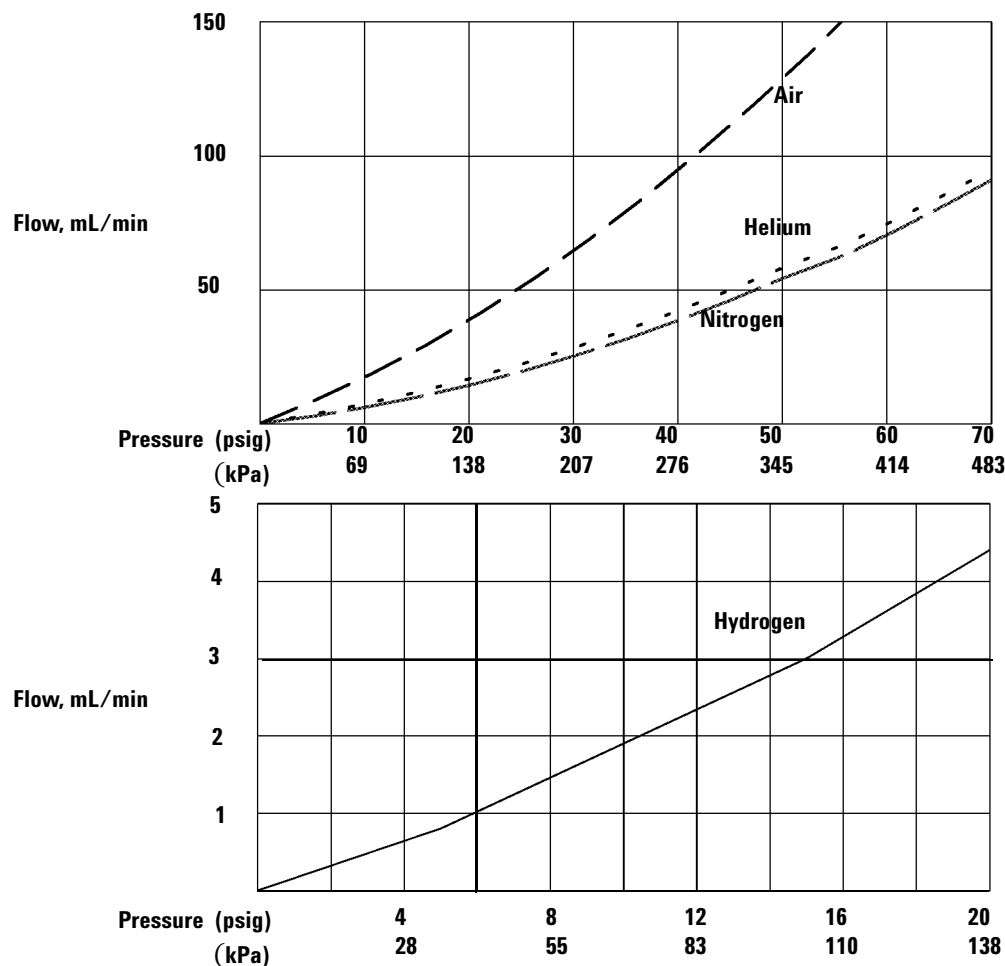

Temperature programming

The NPD is flow sensitive. If you are using temperature programming, in which the column flow resistance changes with temperature, set up the instrument as follows:

- Set the carrier gas in the **Constant flow** mode. Set detector makeup gas to **Constant makeup**.
- If you choose to work in the constant pressure mode, the makeup gas should be set in the **Column +makeup=constant** mode.

NPD required gas purity

Because of its high sensitivity, the NPD requires very pure (at least 99.9995%) gases. We strongly recommend that moisture and organics traps be used on the carrier gas and

all detector gases, including the detector hydrogen, air, and makeup gases. Do not use plastic (including PTFE) tubing, plastic-bodied traps, or O-ring seals.

Setting parameters for the NPD

Before operating the NPD, make sure that detector gases are connected, a column is installed, and the system is free of leaks. Set the oven temperature, inlet temperature, and column flow.

WARNING

Make sure that a column is installed or the NPD column fitting is plugged before turning on the air or hydrogen. An explosion may occur if air and hydrogen are allowed to leak into the oven.

- 1 Select the bead (white ceramic, black ceramic, Blos).
- 2 Select the jet.
- 3 Install bead and jet as required. (See the Maintenance Manual for details.)
- 4 Press **[Config][Front Det]** or **[Config][Back Det]**.
- 5 If you are using makeup gas, verify that the configured makeup gas type is the same as that plumbed to your instrument. Change the gas type, if necessary. Nitrogen is recommended.
- 6 If the displayed **Bead Type** is incorrect, set the Bead Type using the **[Mode/Type]** key.
- 7 Set **Auto Adjust** (**On** recommended).
- 8 Set **Dry Bead** (**On** recommended).
- 9 Press **[Front Det]** or **[Back Det]**.
- 10 Set the detector temperature. The recommended range is 325 to 335 °C.
- 11 Enter a hydrogen flow (3.0 mL/min is recommended). Turn the flow **On**.
- 12 Enter an air flow (60 is recommended for ceramic beads, 120 for Blos beads). Turn the flow **On**.
 - a If you are using **packed columns**, turn off makeup gas and proceed to step 13.
 - b If your **capillary column** is *defined*, choose a flow mode and set the makeup gas flow. For a column in the constant flow mode, choose **Constant makeup**. For a

column in the constant pressure mode, choose **Column +makeup=constant**.

- c If your column is *not defined*, enter a makeup gas flow. Only constant flow is available.

13 Monitor the offset adjustment process.

- a If **Auto Adjust** is **On**, the adjust offset process starts automatically when the detector reaches setpoint. If **Auto Adjust** is **Off**, the Bead Voltage will gradually go to the last setpoint after the bead reaches setpoint temperature and the Dry Bead time has elapsed.
- b If you need to set a new target offset, enter an **Adjust offset** value. Adjust offset starts when the detector reaches setpoint.
- c If **Auto Adjust** is **Off**, you can manually start the Adjust offset process by scrolling to **Adjust offset**, then pressing [**On/Yes**].
- d If your standard operating procedures require that you set the bead voltage directly, see [“Setting NPD bead voltage manually \(optional\)”](#) on page 201.

Selecting an NPD bead type

Three beads are available:

Table 49 NPD beads

Bead type	Part number	Advantages	Disadvantages
White ceramic	G1534-60570	Standard	Phosphorus tails
Black ceramic	5183-2007	Durable, no phosphorus tailing	Lower nitrogen sensitivity, about 40%
Blos bead	G3434-60806	Moisture resistant, long life	



Ceramic beads

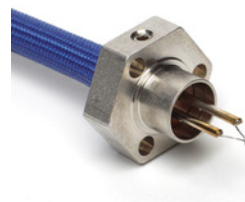

Blos bead

Changing from a ceramic bead to a Bloss bead

CAUTION

The Bloss bead is more delicate than the ceramic beads, and may be distorted during shipping. Before installing a Bloss bead, verify that it is centered and adjust it if necessary.

When you turn the NPD off, the GC remembers the bead voltage used and applies that voltage when the detector is turned back on. If you have changed from a ceramic bead to a Bloss bead, this voltage will be too high and may damage the new bead.

To avoid this, reduce the voltage to the ceramic bead to 0.5 V before turning the detector off. When it restarts, the lower voltage will be applied.

Selecting an NPD jet

Open the oven door and locate the column connection fitting at the base of the detector. It will look like either a capillary optimized fitting or an adaptable fitting.

Capillary optimized fitting



Adaptable fitting

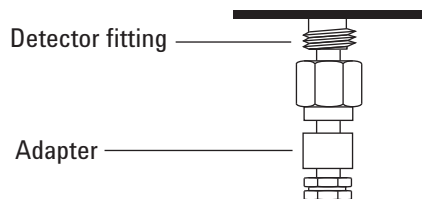

- If you have an application that tends to clog the jet, select a jet with a wider tip id.
- When using packed columns in high column-bleed applications, the jet tends to clog with silicon dioxide.

For capillary optimized fittings, select one of the following from [Table 50](#).

Table 50 Jets for capillary optimized fittings

Figure 3 ID	Jet type	Part number	Jet tip id	Length
1	Capillary with extended jet (recommended)	G1534-80580	0.29 mm (0.011 inch)	51.5 mm
2	Capillary	G1531-80560	0.29 mm (0.011 inch)	43 mm
3	High-temperature	G1531-80620	0.47 mm (0.018 inch)	43 mm

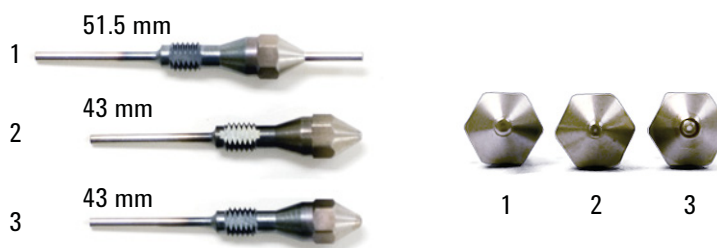

Figure 1 Capillary optimized NPD jets

For the adjustable NPD, select one of the following from [Table 51](#).

Table 51 Jets for adaptable fittings

Figure 4 ID	Jet type	Part number	Jet tip id	Length
1	Capillary with extended jet (recommended)	G1534-80590	0.29 mm (0.11 inch)	70.5 mm
2	Capillary	19244-80560	0.29 mm (0.011 inch)	61.5 mm
3	Capillary, high-temperature	19244-80620	0.47 mm (0.018 inch)	61.5 mm
4	Packed	18710-20119	0.46 mm (0.018 inch)	63.6 mm



Figure 2 Adaptable NPD jets

To configure the NPD

In addition to the **Ignore Ready** and **Makeup gas** type, the NPD requires the following configuration settings. Scroll to each and enable/disable using **[On/Yes]** or **[Off/No]**.

Auto Adjust Bead Recommended **On**. When On, the automatic adjust offset process starts when the bead reaches the temperature setpoint after having been turned off or cooled below 150 °C. Auto adjust starts after **Dry Bead** hold time, if enabled. Auto Adjust Bead uses the adjust offset feature to protect the bead—especially new beads—by making sure that the desired offset is obtained with the lowest possible bead voltage. When Off, the bead voltage will rise as soon as the Dry Bead time elapses, or as soon as the temperature setpoint is reached if Dry Bead is off.

Dry Bead Recommended **On**. When On, the bead temperature holds at 150 °C for 5 minutes before continuing to the setpoint. This allows any condensation to evaporate and be swept out of the detector.

Blos Bead If using a Blos bead, set to **On**. For ceramic beads, set to **Off**. The Blos Bead On setting restricts the allowable bead voltage to the range appropriate for this bead.

Maximum Bead Voltage Display only. Shows the current maximum bead voltage for the configured bead type (4.095 V for ceramic beads, 1.1 V for the Blos bead).

Automatically adjusting NPD bead voltage

Agilent recommends using the Adjust offset feature to automatically determine the lowest bead voltage needed to give the desired response.

When the detector is turned on, the temperature rises at a controlled rate.

- If **Dry Bead** is **On**, temperature holds at 150 °C for 5 minutes to drive off moisture, then continues to the setpoint.
- If **Dry Bead** is **Off**, the temperature rises directly to the setpoint.

When the temperature reaches the setpoint, the Bead Voltage gradually rises until it produces the desired output.

Adjust offset

When you enter a value here, or press **[On/Yes]** to use the stored value, detector gas flows turn on, the bead heats, and the bead voltage adjusts until **Output** is stable and equal to the entered value. There are five stages of **Adjust offset**.

Detector off When the detector is off, **Adjust offset** and **Bead voltage** are **Off** and initial **Output** is displayed.

Detector on—detector temperature less than 150 °C. When you enter an **Adjust offset** value or press **[On]**, detector gases turn on and the display blinks the **Temp not ready** message.

Detector on—waiting for oven and/or detector to reach temperature setpoint and equilibrium. If the oven or detector is not at setpoint, the display continues to blink the **Temp not ready** message.

Detector on—Dry Bead On If **Dry Bead** is **On**, the temperature rise holds at 150 °C for 5 minutes to remove moisture, then continues to the setpoint.

Detector on—during adjust offset. When the detector and oven temperatures reach setpoint and equilibrate, the **Adjust offset** process begins. The bead voltage is slowly increased until the output is close to the **Adjust offset** value. The display blinks **Detector Slewing**.

Detector on and ready. When the **Adjust offset** value is reached, the **Adjust offset** line reads **Done** and displays the offset target setpoint. Your detector is on and ready. The display shows the actual **Bead voltage**.

Setting NPD adjust offset on the clock table

You can use the **Clock table** feature to begin **Adjust offset** at a specified time.

Aborting NPD adjust offset

Press **[Delete]** with the cursor on the **Adjust offset** line. This cancels the adjustment without turning off the detector gases and bead voltage.

Extending the NPD bead life

These actions, together with the automated heatup and adjust procedures, can extend ceramic bead life considerably.

- Use the lowest practical **Adjust offset** value. This will result in a lower Bead Voltage during operation.
- Run clean samples.
- Turn the bead off when not in use.

- Keep the detector temperature high (320 to 335 °C).
- Turn the hydrogen flow off during solvent peaks and between runs.

Turning hydrogen off during a solvent peak

When using the NPD, the baseline shifts after a solvent peak and can take some time to stabilize, especially with chlorinated solvents. To minimize this effect, turn off the hydrogen flow during the solvent peak and turn it back on after the solvent elutes. With this technique, the baseline recovers to its original value in less than 30 seconds. This also extends the life of the bead. The hydrogen can be turned on and off automatically as part of a Run Table. See “Run Time Programming” on page 12.

Turning hydrogen off between runs

To extend bead life, turn off the hydrogen flow between runs. Leave all other flows and the detector temperature on. Turn on the hydrogen flow for the next run; the bead will ignite almost immediately. The process can be automated with Run Table entries.

Turning off the detector

CAUTION

If you turn **Adjust offset [Off]** at any time, the bead voltage, hydrogen, and air flows all turn off.

Setting the initial bead voltage for new beads

Before you turn on the bead for the first time, manually set its voltage to a safe value so that the new bead is not destroyed.

- 1 Make sure **Adjust Offset** is turned **Off**.
- 2 After the temperature stabilizes at setpoint, set the initial Bead Voltage, depending on bead type:
 - Bloss bead: 0.0 V to 0.5 V
 - Ceramic bead (white or black): 0.0 V to 2.0 V

Setting NPD bead voltage manually (optional)

Bead voltage shows the voltage used to heat the bead. It can be a value derived from the **Adjust offset** value, or can be entered as a setpoint. Entering a setpoint causes the voltage to change at 13 mV/second until it reaches the setpoint provided that

- the detector is at the temperature setpoint
- temperature is at least 150 °C
- gas flows are on
- **Dry Bead** time, if **On**, has elapsed

Bead voltage is also useful for small adjustments between runs. If you observe a baseline drift, you can enter a small, one-time change to compensate for the drift.

If you are not using the recommended Adjust offset process, note that large voltage jumps reduce bead life. Use increments no greater than 0.05 V, spaced 10 seconds apart, until you reach the desired offset.

New beads

After a new bead reaches the initial voltage, begin to increase the voltage value in 0.05 V increments until the bead ignites. Wait about 10 seconds between each voltage adjustment. Monitor the detector output. When the bead ignites, the output will rise suddenly, then decrease towards a more stable value. It is best to allow the NPD to remain in this state without further adjustment for about 24 hours. Then you may adjust the bead voltage in small increments (0.05 to 0.1 V) until reaching the desired offset. With a clean environment, clean gas supplies, and low bleed column, a typical offset may decrease 6-12 pA during a 24 hour period.

Typical voltages for new ceramic beads range from 2.5 to 3.7 volts. Higher values reduce bead life.

Typical voltages for new Blos beads range from 0.5 to 1.0 V.

About the FPD⁺

The sample burns in a hydrogen-rich flame, where some species are reduced and excited. The gas flow moves the excited species to a cooler emission zone above the flame where they decay and emit light. A narrow bandpass filter selects light unique to one species, while a shield prevents intense carbon emission from reaching the photomultiplier tube (PMT).

The light strikes a photosensitive surface in the PMT where a light photon knocks loose an electron. The electron is amplified inside the PMT for an overall gain of up to a million.

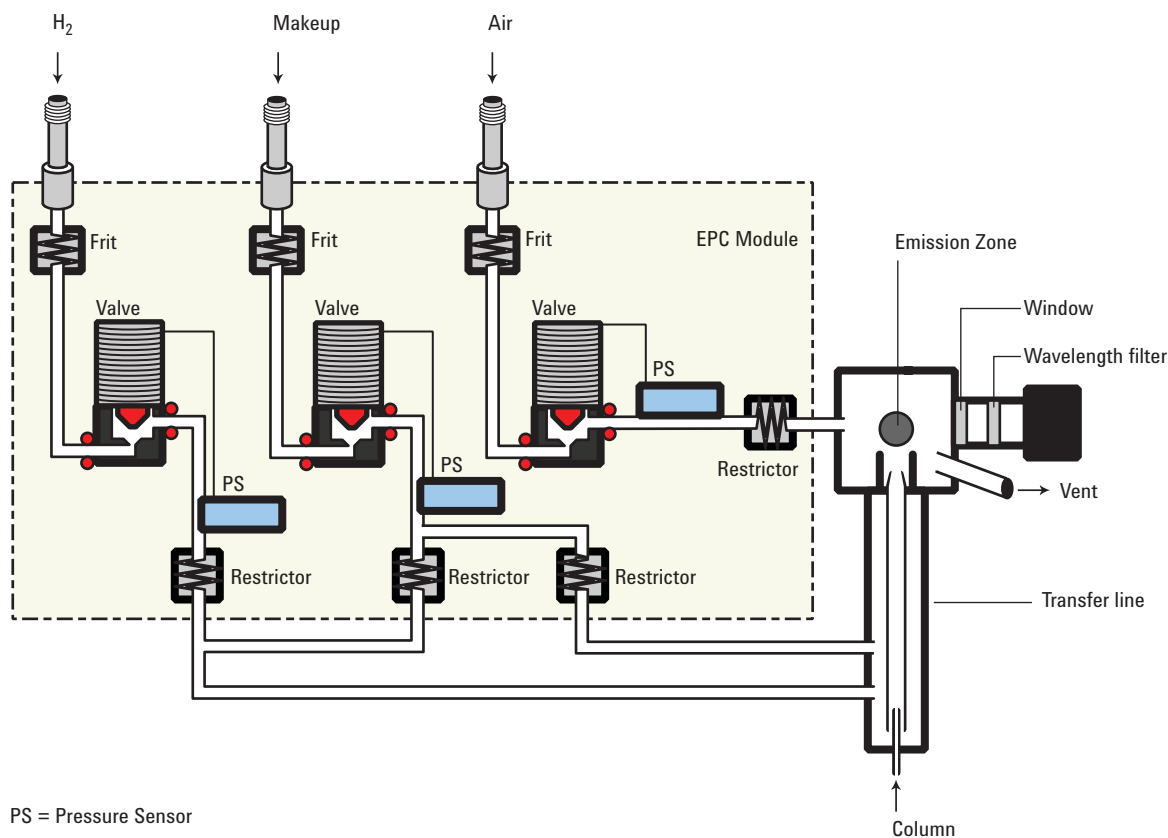

Figure 3 FPD⁺ gas flows

The current from the PMT is amplified and digitized by the FPD⁺ electronics board. The signal is available either as a digital signal on the communications output or as a voltage signal on the analog output.

The FPD⁺ should not be stored at temperatures above 50 °C, based on the original manufacturer's specifications for the PMT.

FPD⁺ gas flows

The hydrogen fuel gas and makeup gas mix at the EPC module, and enter the bottom of the detector where the column enters the transfer line. See [Figure 3](#). This gas mixture eliminates any dead volume near the column entrance before mixing with air in the emission block for combustion.

A second flow of makeup gas is used to sweep the volume between the thin-walled tube (that carries the column sample stream) and the transfer line walls. This gas flow also enters the emission block but is separate from the sample stream. The purge flow rate is not measured directly, but is controlled by a fixed restrictor and the makeup flow setting. A makeup flow setting of 60 mL/min will result in about 12 mL/min of purge flow.

The total flow from the detector is:

$$\text{column flow} + \text{makeup flow} + \text{purge flow} = \text{total flow}$$

However, the total flow that carries the sample is equal to just the column flow plus the makeup flow.

FPD⁺ linearity

Several mechanisms produce sulfur emission. The excited species is diatomic, so that emission intensity is approximately proportional to the square of the sulfur atom concentration.

The excited species in the phosphorus mode is monatomic, leading to a linear relationship between emission intensity and atom concentration.

FPD⁺ Lit Offset

The default **Lit Offset** is 2.0 pA.

FPD⁺ photomultiplier protection

The PMT is extremely sensitive to light. Always turn the **PMT voltage** off (which turns off the high voltage to the PMT) before removing the PMT housing or opening the emissions chamber. Failing to do this can destroy the PMT.

Even with the **PMT voltage** off, protect the PMT from room light. Cap the housing when removed, place it end down to exclude light, reduce room light level before exposing the PMT, and so on. A brief exposure (always with the **PMT voltage** turned off) will not damage it but prolonged exposure will cause a gradual loss of sensitivity.

FPD⁺ optical filters

The filters are marked on the edge with the transmission wavelength. Each filter has a small arrow or triangle on its side which must point toward the PMT when installed.

The sulfur filter is silvery on both sides and transmits at 393 nanometers.

The phosphorus filter is yellow/green and transmits at 525 nanometers.

Inlet liners for use with the FPD⁺

Compounds containing sulfur may adsorb on an inlet liner and degrade the GC's performance. Use deactivated, clean liners or a cool on-column inlet, which injects directly onto the column.

For best results with splitless injection, use liner 5181-3316.

FPD⁺ temperature considerations

The FPD⁺ provides two temperatures zones, one for the transfer line (the main detector temperature) and one for the emission block. For the transfer line temperature, we recommend a temperature that is 25 °C higher than the highest column temperature.

The emission block temperature ranges from 125–175 °C. Typically, the default temperature of 150 °C is sufficient for most applications. However, when setting the emission block temperature, consider the following:

- If using the GC oven at high temperature (>325 °C) with the transfer line set to 400 °C, set the emission block temperature to 165 °C to avoid a system Not Ready if the emission block temperature cannot be maintained.
- If using the transfer line at 400 °C, set the emission block temperature to at least 150 °C to avoid a system Not Ready.
- For sulfur analyses, the highest area response will be realized with the lowest possible emission block temperature.
- For phosphorus analyses, the area response is independent of the emission block temperature.

FPD⁺ gas purity

High-purity gases have a lower sulfur content. Standard purity gases have a higher sulfur content which impairs sulfur detection in the compound being studied. Instrument or Chromatographic grades work well.

Agilent recommends using helium carrier, nitrogen makeup gas, and air with 99.9995% purity or better. Use carbon, oxygen, and moisture traps. Select traps to remove sulfur compounds from detector air and nitrogen gases. A helium getter is also recommended. See the [GC, GC/MS, and ALS Site Preparation Guide](#) for and the Agilent web site at <http://www.agilent.com> more information.

FPD⁺ gas flows

Table 52 gives the flows for the maximum sensitivity FPD⁺ flame, which is hydrogen-rich and oxygen-poor.

Table 52 Recommended flows

	mL/min
Carrier (hydrogen, helium, nitrogen, argon)	
Packed columns	10 to 60
Capillary columns	1 to 5
Detector gases	
Hydrogen	60
Air	60
Carrier + makeup	60

Helium, either as carrier or makeup gas, may cool the detector gases below the ignition temperature. We recommend using nitrogen rather than helium.

Lighting the FPD⁺ flame

Before trying to light the flame, heat the detector to operating temperature and let it stabilize.

During the ignition sequence, the detector does the following:

- 1 Until the detector temperature zones reach setpoint, the GC purges the detector with all gas flows.
- 2 Once the detector stabilizes at its thermal setpoints, the GC turns off hydrogen and makeup gas flows. Carrier and air flows remain on.
- 3 Sets air flow to 500 mL/min.
- 4 Turns the glow plug ignitor on.
- 5 Ramps the hydrogen flow from 10 to 70 mL/min.
- 6 Resets the air flow to the air flow setpoint.
- 7 Resets the hydrogen flow to the hydrogen flow setpoint.
- 8 Turns the makeup gas on.
- 9 Compares the signal change with the **Lit offset** value. If the change is greater than **Lit offset**, declares the flame on (lit). If it is less, declares the flame off (not lit).

For this process to work, there must be enough air pressure to the pneumatics module to provide up to 500 mL/min flow. We recommend a supply pressure of at least 60 psi. See the [Installation and First Startup](#) manual.

Manual ignition

- 1 Press [**Front Det**] or [**Back Det**].
- 2 Scroll to **Flame**. Press [**On/Yes**]. The flame ignition sequence begins.

Automatic ignition

If the FPD⁺ output with the flame on falls below the flame-off output plus the **Lit offset** value, this is interpreted as a flame-out condition. The FPD⁺ runs the flame ignition sequence to relight the flame. If this fails, it runs the sequence again. If the second attempt also fails, the detector shuts down all functions except temperature and makeup gas flow.

Setting parameters for the FPD⁺

WARNING

Verify that a column is installed or the FPD⁺ fitting is plugged before turning on the air or hydrogen. An explosion may occur if air and hydrogen are allowed to leak into the oven.

- 1 Press **[Front det]** or **[Back det]**.
- 2 Set the detector temperature. Scroll to **Temperature** and input the desired value, and press **[Enter]**. It must be greater than 120 °C for the flame to light.
- 3 Scroll to **H2 flow** and change the hydrogen flow rate, if desired. Press **[Enter]**. If the flame is not lit, press **[Off/No]** to turn off the flow. (It is not good practice to pass uncombusted hydrogen into the air. The hydrogen flow will be turned on automatically when igniting the flame.)
- 4 Scroll to **Air flow** and change the air flow rate, if desired. Press **[Off/No]** to turn off the flow for now.
- 5 If you are using packed columns, turn off the makeup gas and proceed to step 9.
- 6 If you are using capillary columns, scroll to the **Makeup** parameter:
 - a Verify that makeup gas type is the same as that plumbed to your instrument. The configured gas type is shown next to **Makeup** in the parameter list. Change the gas type, if necessary.
 - b If your capillary column is *defined*, choose a flow mode and set the makeup gas flow or combined flow.
 - c If your capillary column is *not defined*, enter a makeup gas flow. Only constant flow is available.
- 7 Scroll to **PMT voltage** and make sure it is turned on.
- 8 Optionally, set the emission block temperature. (Normally, the default temperature of 150 °C is sufficient for most applications.) Scroll to **Emission Block**, input the desired temperature, and press **[Enter]**. See [“FPD⁺ temperature considerations”](#) on page 204 for more information.
- 9 Scroll to **Flame** and press **[On/Yes]**. This starts the automatic ignition sequence (see [“Lighting the FPD⁺ flame”](#) on page 206).

On successful ignition, the signal increases. Typical signal output increases are 4 to 40 pA in sulfur mode, and 10 to 70 pA in phosphorus mode. You can also verify that the

flame is lit by holding a cold, shiny surface, such as a mirror or chrome-plated wrench, over the vent exit. Steady condensation indicates that the flame is lit.

About the FPD

The sample burns in a hydrogen-rich flame, where some species are reduced and excited. The gas flow moves the excited species to a cooler emission zone above the flame where they decay and emit light. A narrow bandpass filter selects light unique to one species, while a shield prevents intense carbon emission from reaching the photomultiplier tube (PMT).

The light strikes a photosensitive surface in the PMT where a light photon knocks loose an electron. The electron is amplified inside the PMT for an overall gain of up to a million.

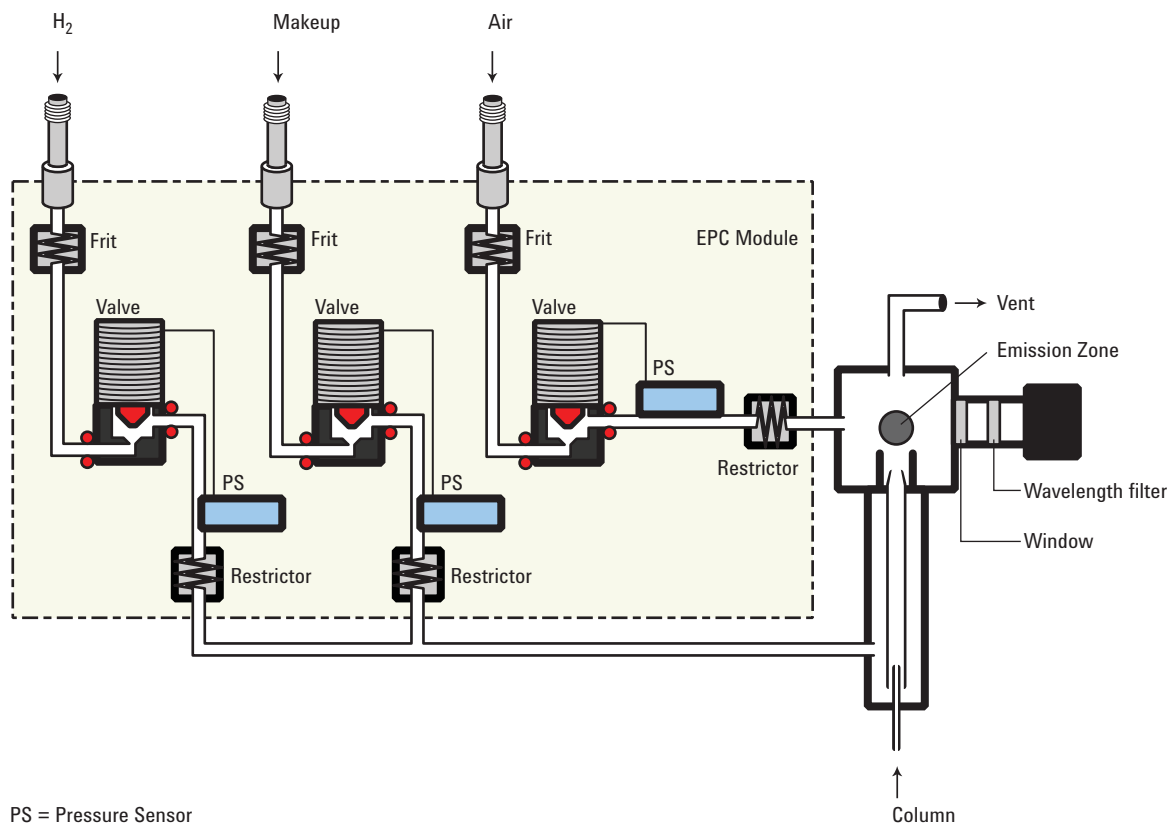

The current from the PMT is amplified and digitized by the FPD electronics board. The signal is available either as a digital signal on the communications output or as a voltage signal on the analog output.

The FPD should not be stored at temperatures above 50 °C, based on the original manufacturer's specifications for the PMT.

FPD linearity

Several mechanisms produce sulfur emission. The excited species is diatomic, so that emission intensity is approximately proportional to the square of the sulfur atom concentration.

The excited species in the phosphorus mode is monatomic, leading to a linear relationship between emission intensity and atom concentration.

FPD Lit Offset

The default **Lit Offset** is 2.0 pA.

Starting Up and Shutting Down the FPD

The FPD creates a great deal of water vapor when the flame is on. This could condense in the vent tube on top of the detector and drop onto the flame, possibly extinguishing it. To avoid this, turn the heaters on, wait 20 minutes for the vent to heat up, and then ignite the flame. Water vapor will now make it over the top of the vent tube before condensing.

For similar reasons, extinguish the flame before turning the heaters off.

FPD photomultiplier protection

The PMT is extremely sensitive to light. Always turn the **PMT voltage** off (which turns off the high voltage to the PMT) before removing the PMT housing or opening the emissions chamber. Failing to do this can destroy the PMT.

Even with the **PMT voltage** off, protect the PMT from room light. Cap the housing when removed, place it end down to exclude light, reduce room light level before exposing the PMT, and so on. A brief exposure (always with the **PMT voltage** turned off) will not damage it but prolonged exposure will cause a gradual loss of sensitivity.

FPD optical filters

The filters are marked on the edge with the transmission wavelength. Each filter has a small arrow on its side which must point toward the PMT when installed.

The sulfur filter is silvery on both sides and transmits at 393 nanometers.

The phosphorus filter is yellow/green and transmits at 525 nanometers.

Inlet liners for use with the FPD

Compounds containing sulfur may adsorb on an inlet liner and degrade the GC's performance. Use deactivated, clean liners or a cool on-column inlet, which injects directly onto the column.

For best results with splitless injection, use liner 5181-3316.

FPD temperature considerations

The minimum detector temperature to prevent water condensation is 120 °C. We recommend a temperature that is 25 °C higher than the highest column temperature, but no higher than 250 °C.

FPD gas purity

High-purity gases have a lower sulfur content. Standard purity gases have a higher sulfur content which impairs sulfur detection in the compound being studied. Instrument or Chromatographic grades work well.

Agilent recommends using helium carrier, nitrogen makeup gas, and air with 99.9995% purity or better. Use carbon, oxygen, and moisture traps. Select traps to remove sulfur compounds from detector air and nitrogen gases. A helium getter is also recommended. See the [GC, GC/MS, and ALS Site Preparation Guide](#) for and the Agilent web site at <http://www.agilent.com> more information.

FPD gas flows

[Table 52](#) gives the flows for the maximum sensitivity FPD flame, which is hydrogen-rich and oxygen-poor.

Table 53 Recommended flows

	Sulfur mode flows, mL/min	Phosphorus mode flows, mL/min
Carrier (hydrogen, helium, nitrogen, argon)		
Packed columns	10 to 60	10 to 60
Capillary columns	1 to 5	1 to 5

Table 53 Recommended flows (continued)

	Sulfur mode flows, mL/min	Phosphorus mode flows, mL/min
Detector gases		
Hydrogen	50	75
Air	60	100
Carrier + makeup	60	60

Helium, either as carrier or makeup gas, may cool the detector gases below the ignition temperature. We recommend using nitrogen rather than helium.

Lighting the FPD flame

Before trying to light the flame, have the detector at operating temperature. Removing the condensate tubing may help, but be sure to replace it before making runs.

It is difficult to light the flame with the flows shown in [Table 52](#), particularly in the sulfur mode. If the flame will not light with the sulfur mode flows shown, change to the phosphorus mode flows. After ignition, gradually reduce the flows to the sulfur values. Some experimentation will be needed.

When either of the flame ignition methods in this section is used, the FPD automatically performs this sequence:

- 1 Turns all detector gases—air, hydrogen, makeup—off. Carrier remains on.
- 2 Sets air flow to 200 mL/min.
- 3 Turns the glow plug ignitor on.
- 4 Ramps the hydrogen flow from 10 to 70 mL/min.
- 5 Resets the air flow to the air flow setpoint.
- 6 Resets the hydrogen flow to the hydrogen flow setpoint.
- 7 Turns the makeup gas on.
- 8 Compares the signal change with the **Lit offset** value. If the change is greater than **Lit offset**, declares the flame on (lit). If it is less, declares the flame off (not lit).

For this process to work, there must be enough air pressure to the pneumatics module to provide 200 mL/min flow. We recommend a supply pressure of 90 psi.

Manual ignition

- 1 Press [**Front Det**] or [**Back Det**].
- 2 Scroll to **Flame**. Press [**On/Yes**]. The flame ignition sequence begins.

Automatic ignition

If the FPD output with the flame on falls below the flame-off output plus the **Lit offset** value, this is interpreted as a flame-out condition. The FPD runs the flame ignition sequence to relight the flame. If this fails, it runs the sequence again. If the second attempt also fails, the detector shuts down all functions except temperature and makeup gas flow.

Setting parameters for the FPD

WARNING

Verify that a column is installed or the FPD fitting is plugged before turning on the air or hydrogen. An explosion may occur if air and hydrogen are allowed to leak into the oven.

- 1 Press [**Front det**] or [**Back det**].
- 2 Set the detector temperature. It must be greater than 120 °C for the flame to light.
- 3 Change the hydrogen flow rate, if desired. Press [**Off/No**].
- 4 Change the air flow rate, if desired. Press [**Off/No**].
- 5 If you are using packed columns, turn off the makeup gas and proceed to step 9.
- 6 If you are using capillary columns:
 - a Verify that makeup gas type is the same as that plumbed to your instrument (next to **Makeup** in the parameter list). Change the gas type, if necessary.
 - b If your capillary column is *defined*, choose a flow mode and set the makeup gas flow or combined flow.
 - c If your capillary column is *not defined*, enter a makeup gas flow. Only constant flow is available.
- 7 Scroll to **Flame** and press [**On/Yes**]. This turns on the air and hydrogen and initiates the ignition sequence.

On ignition, the signal increases. Typical levels are 4 to 40 pA in sulfur mode, 10 to 70 pA in phosphorus mode. Verify that the flame is lit by holding a cold, shiny

surface, such as a mirror or chrome-plated wrench, over the vent exit. Steady condensation indicates that the flame is lit.



6 Valves

About Valves	216
The Valve Box	217
Heating the valves	217
Valve temperature programming	218
Configuring an Aux thermal zone	218
Valve Control	219
The valve drivers	219
The internal valve drivers	219
The external valve drivers	220
Valve Types	221
Configuring a Valve	222
Controlling a Valve	223
From the keyboard	223
From the run or clock time tables	223
Simple valve: column selection	223
Gas sampling valve	224
Multiposition stream selection valve with sampling valve	225



About Valves

Valves may be used to alter the usual inlet/column/detector flow path in the GC. Sampling valves can replace the inlet, switching valves can select columns, multiposition valves, used in conjunction with sampling valves, can perform the same functions for sample streams that an ALS performs for liquid samples.

The Valve Box

The GC holds up to four valves in a heated valve box on top of the oven.

The valve box is the preferred location for valves because it is a stable temperature zone, isolated from the column oven.

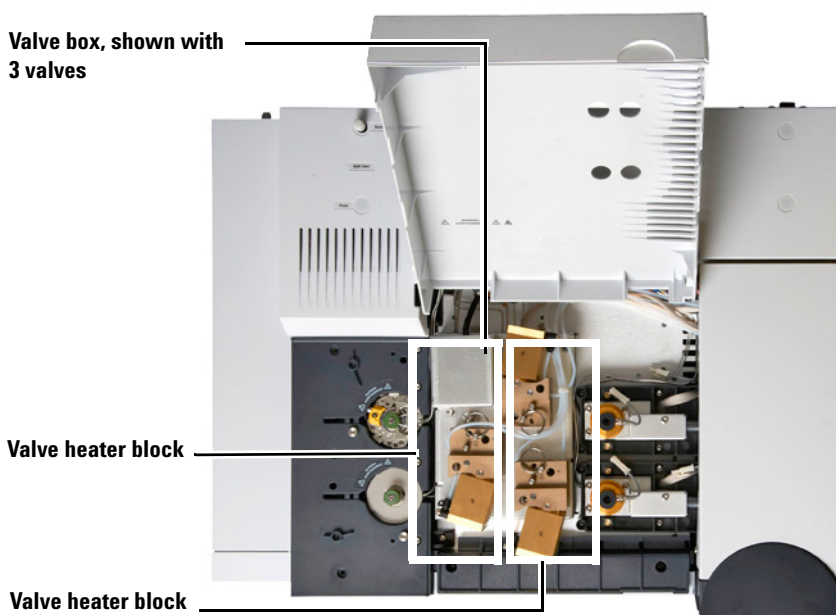

Figure 4 Diagram of valve locations on GC

Valves may also be mounted inside the column oven.

Heating the valves

The valve box contains two heated blocks, each with two valve mounting locations (shaded in [Figure 4](#)). The middle hole on each block is used to pass tubing into the column oven.

If two valves are used, mount them on the same block. This allows them to be heated using only one control channel (**Aux Temp 1** or **Aux Temp 2**, depending on how the heaters are wired). With more than two valves, both channels must be used for heating the two blocks. Set them at the same temperature.

Valve temperature programming

Most valve applications are isothermal; however, you can define three temperature ramps if desired. Press [**Aux Temp #**], then [**1**] or [**2**]. Program this ramp the same as an oven ramp. Refer to [“Setting the oven parameters for ramped temperature”](#) on page 150 for more information.

Configuring an Aux thermal zone

To configure a thermal Aux zone (1 or 2), press [**Config**][**Aux Temp #**], then [**1**] or [**2**]. Press [**Mode/Type**], then select the type of device to be controlled. Press [**Enter**].

Valve Control

Valves can be controlled manually from the keyboard or as part of a clock or run time program. Note that only sampling valves automatically reset at the end of a run. Other valve types remain at the new position until activated again. For other valve types, you must include any desired resets in the program.

The valve drivers

A valve driver is the software and circuitry in the GC that controls a valve or related function. There are eight drivers known as Valve 1 through Valve 8.

Table 54 Valve drivers

Valve number	Type	Volts	Power or current	Use
1, 2, 3, and 4	Current source	24 VDC	13 watts	Pneumatic valve control
5 and 6	Current source	24 VDC	100 mA	Relays and low-power devices
7 and 8	Contact closure	48 VDC or 48 VAC RMS		Control an external current source

The internal valve drivers

Valve drivers 1 through 4 are usually used to control pneumatically operated valves mounted in the valve box. The wiring for these appears at a set of connectors inside the right cover of the GC.

Pneumatically driven valves are controlled by solenoids mounted near the connectors that control the flow of air to the valve actuators.

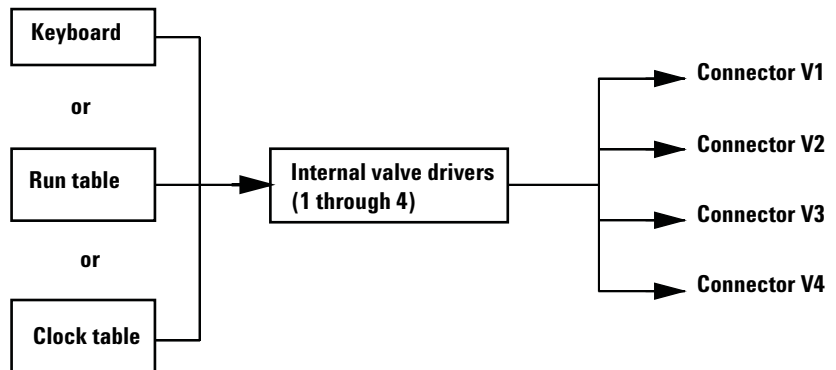

There is no direct relationship between the location of a valve in the valve box and the driver that controls it. This depends on how the solenoids are wired and the actuators are plumbed.

Manual valves must be switch by hand, and are heated or unheated.

The external valve drivers

Valve drivers 5 and 6 control a current that may be used to drive a relay or other low-power device. Valve drivers 7 and 8 switch a current from an external source. Electrical details are in [Table 54](#) on page 219.

These drivers, particularly Valve 7 and 8, may be used to control a motor driven multiposition valve for stream selection.

All four of these drivers appear on the External Event connector on the back of the GC.

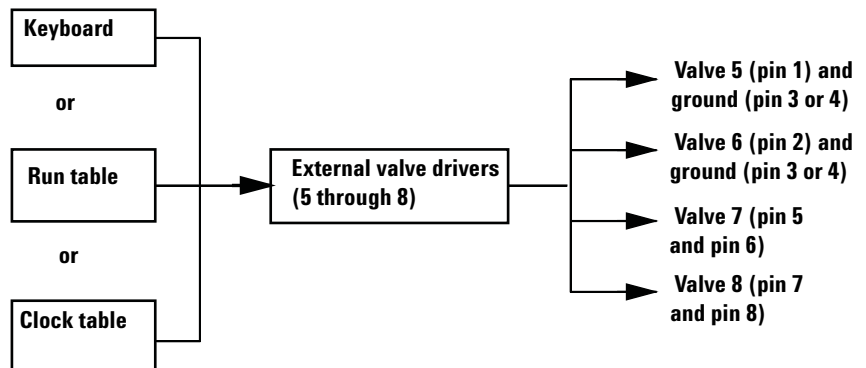

Valve Types

The possible valve types are:

Sampling A two-position (load and inject) valve. In load position, an external sample stream flows through an attached (gas sampling) or internal (liquid sampling) loop and out to waste. In inject position, the filled sampling loop is inserted into the carrier gas stream. When the valve switches from **Load** to **Inject**, it starts a run if one is not already in progress. See the example on [page 224](#).

Switching A two-position valve with four, six, or more ports. These are general-purpose valves used for such tasks as column selection, column isolation, and many others. For an example of valve control, see [page 225](#).

Multiposition Also called a stream selection valve. It is usually used to select one from a number of gas streams and feed it to a sampling valve for analysis. It has a special actuator that advances the valve one position each time it is activated, or it may be motor driven. An example that combines a stream selection valve with a gas sampling valve is on [page 225](#).

Other Could be anything.

Not installed Self-explanatory.

Configuring a Valve

- 1 Press **[Config]**. Scroll to **Valve #**.
- 2 Enter the valve number and press **[Enter]**. The current valve type is displayed.
- 3 To change the valve type, press **[Mode/Type]**, select the new valve type, and press **[Enter]**.

Controlling a Valve

From the keyboard

Valves (except multiposition valves) have two positions controlled by the **[On]** and **[Off]** keys. The keyboard commands for two-position valves are:

[Valve #] <scroll to the valve> **[On]** Rotates valve to one stop

and

[Valve #] <scroll to the valve> **[Off]** Rotates valve to the other stop

From the run or clock time tables

The **Valve On** and **Valve Off** commands can be run time or clock time programmed. See “[Run Time Programming](#)” on page 12 and “[Clock Time Programming](#)” on page 15.

If a valve is rotated by a run time program, it is *not* automatically returned to its initial position at the end of the run. You must program this reset operation yourself.

Simple valve: column selection

This is the plumbing for a single valve, configured as a switching valve, that selects one of two columns for analysis. It has no configuration parameters.

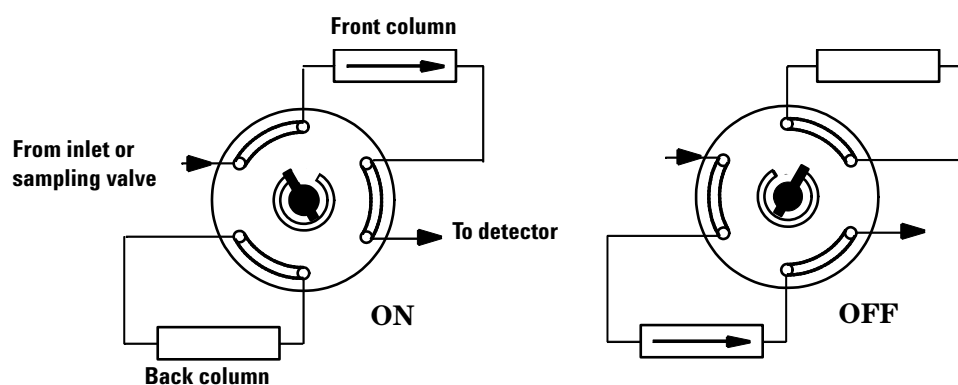

The column is selected by pressing:

[Valve #] <scroll to valve #> **[On]** (for the front column) or **[Off]** (for the back column).

Use a run table entry to ensure that the valve is in the Off state between runs.

Gas sampling valve

If a valve is configured as a gas sampling valve, it starts a run automatically when it is switched to the Inject position. This can be done with a keyboard command or by a subsequence or clock table entry. You may have two gas sampling valves installed.

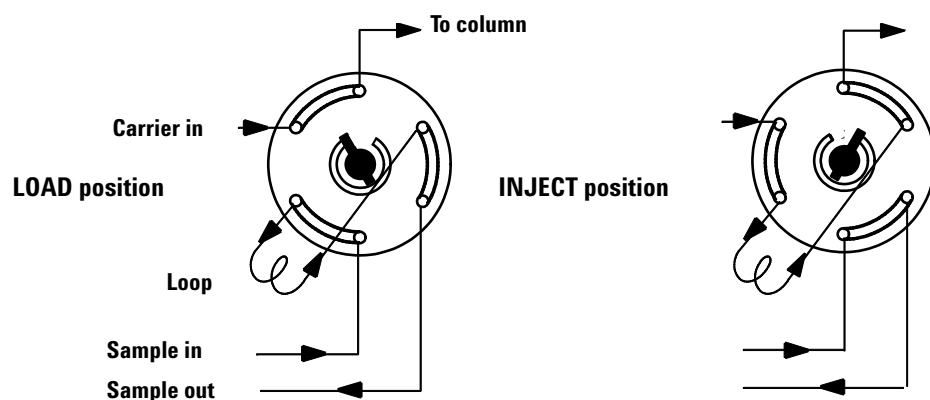

Load position The loop is flushed with a stream of the sample gas. The column is flushed with carrier gas.

Inject position The filled loop is inserted into the carrier gas stream. The sample is flushed onto the column. The run starts automatically.

Carrier gas may be provided by an (optional) auxiliary gas channel. To do this, configure the column and specify an Aux # channel as the inlet. The channel then becomes programmable with four operating modes.

Sampling valves have two positions:

Load position The loop (external for gas sampling, internal for liquid sampling) is flushed with a stream of the sample. The column is flushed with carrier gas.

Inject position The filled loop is inserted into the carrier gas stream. The sample is flushed onto the column. The run starts automatically.

The sampling valve control parameters are:

Load time Time in minutes that the valve remains in the Load position before becoming ready.

Inject time Time in minutes that the valve remains in the Inject position before returning to the Load position.

The sampling valve cycle is:

- 1 The sampling valve rotates to the Load position. **Load time** begins. Valve is not ready.
- 2 **Load time** ends. The valve becomes ready.
- 3 If everything else is ready, the GC becomes ready. If anything is not ready:
 - If you are using Clock Table or sequence control, the GC waits until everything is ready, then executes the valve inject command.
 - If you are not using Clock Table or sequence control, the valve injection can be made at any time from the keyboard.
- 4 The sampling valve rotates (keyboard command or sequence control) to the Inject position. **Inject time** begins. The run begins.
- 5 **Inject time** ends. Return to step 1.

Multiposition stream selection valve with sampling valve

Several manufacturers provide multiposition stream selection valves that can be driven by valve drivers 1 through 4. Only one multiposition valve can be configured.

If a valve is configured as a multiposition valve and has a BCD position output connected to the GC, the valve position can be selected directly.

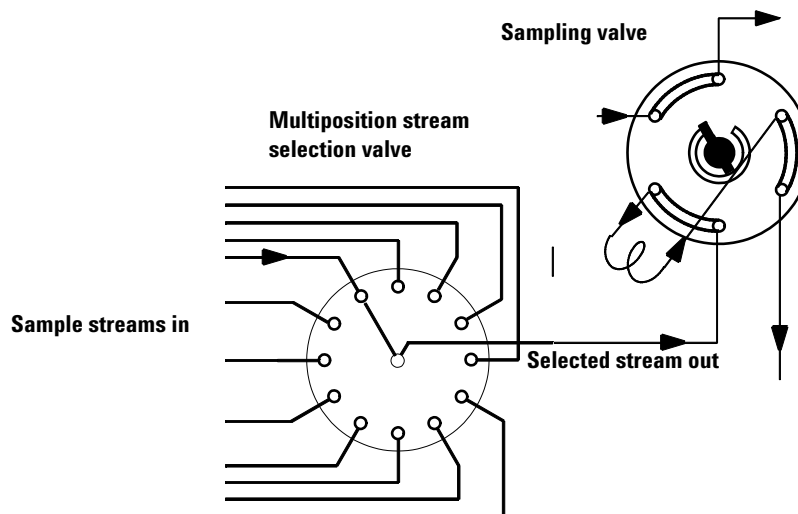

If the GC has one valve configured as a multiposition valve and another configured as a gas or liquid sampling valve, it assumes that they are to be used in series. This “double configuration” can be used to replace an automatic liquid sampler and sample tray in an analytical sequence. The multiposition valve becomes the sample tray; the sampling valve becomes the injector.

Two configuration parameters provide mechanical and electrical compatibility with most multiposition valve actuators.

Switching time In seconds, is a delay between successive actuator movements. It allows time for the actuator mechanism to prepare for the next movement.

Invert BCD Complements the BCD input; 1’s become 0’s and 0’s become 1’s. This accommodates coding convention differences among manufacturers.

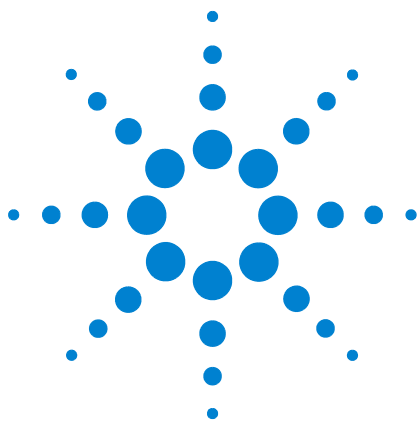

7 GC Output Signals

About Signals	228
Signal Types	229
Value	229
Analog Signals	231
Analog zero	231
Analog range	231
Analog data rates	232
Selecting fast peaks (analog output)	233
Digital Signals	234
Digital zero	234
Signal Freeze and Resume	234
Data rates with Agilent data systems	235
Column Compensation	238
Creating a column compensation profile	239
Making a run using analog output column compensation	239
Plotting a stored column compensation profile	240
Test Plot	241



About Signals

Signal is the GC output to a data handling device, analog or digital. It can be a detector output or the output from flow, temperature, or pressure sensors. Two signal output channels are provided.

Signal output can be either analog or digital, depending on your data handling device. Analog output is available at either of two speeds, suitable to peaks with minimum widths of 0.004 minutes (fast data rate) or 0.01 minutes (normal rate). Analog output ranges are 0 to 1 V, 0 to 10 V, and 0 to 1 mV.

Digital output rates are set by your Agilent data system, such as OpenLAB CDS or MassHunter Workstation.

Signal Types

When assigning detector signals, use the **[Mode/Type]** key and choose from the Signal Type parameter list, or press a key or combination of keys.

[Front], **[Back]**, **[-]**, and **[Column Comp]** will work, alone or in combination. For example, press **[Back]** for back detector or **[Back] [-] [Front]** for back detector minus front detector. The menu choices for signal subtraction (**Front - Back** and **Back - Front**) only appear if the front and back detectors are of the same type.

The nondetector signals are test plot, thermal, pneumatic, and diagnostic. Access them by pressing **[Mode/Type]**. Diagnostic signals are for use by your service representative and are not described in detail here.

Signal type can be programmed as a run time event.

Value

Value on the signal parameter list is the same as **Output** on the detector parameter list if your signal type is **Front** or **Back**. If you are subtracting one signal from another (as in **Front - Back**), the signal **Value** will be the difference. You cannot enter a setpoint for **Value**.

A conversion factor may be involved when interpreting **Value**—for example, one FID unit is one picoamp; one uECD unit is 1 Hz. The units for detector and other signals are listed below.

Table 55 Signal conversions

Signal type	1 display unit is equivalent to:
Detector:	
FID, NPD	1.0 pA (1.0×10^{-12} A)
FPD	150 pA (150×10^{-12} A)
TCD	25 μ V (2.5×10^{-5} V)
μ ECD	1 Hz
Analog input board (use to connect the GC to non-Agilent detector)	15 μ V
Nondetector:	
Thermal	1 $^{\circ}$ C

Table 55 Signal conversions (continued)

Signal type	1 display unit is equivalent to:
Pneumatic:	
Flow	1 mL/min
Pressure	1 pressure unit (psi, bar, or kPa)
Diagnostic	Mixed, some unscaled

Analog Signals

If you use an analog recorder, you may need to adjust the signal to make it more usable. **Zero** and **Range** in the Signal parameter list do this.

Analog zero

Zero Subtracts value entered from baseline. Press [**On/Yes**] to set to current **Value** or [**Off/No**] to cancel.

This is used to correct baseline elevation or offsets. A common application is to correct a baseline shift that occurs as the result of a valve operation. After zeroing, the analog output signal is equal to the **Value** line of the parameter list minus the **Zero** setpoint.

Zero can be programmed as a run time event. For details, see “[Run Time Programming](#)” on page 12.

- 1 Verify that the detector is on and in a ready state.
- 2 Press [**Analog Out 1**] or [**Analog Out 2**].
- 3 Scroll to **Zero**.
- 4 Press [**On/Yes**] to set **Zero** at the current signal value,
or
Enter a number between -500000 and +500000. A value smaller than the current **Zero** shifts baseline up.

Analog range

Range Scales data coming from the detector

Range is also referred to as gain, scaling, or sizing. It sizes the data coming from the detector to the analog signal circuits to avoid overloading the circuits (clamping). **Range** scales all analog signals.

If a chromatogram looks like A or B in the next figure, the data needs to be scaled (as in C) so that all peaks are visible on the paper.

Valid setpoints are from 0 to 13 and represent 2^0 (=1) to 2^{13} (=8192). Changing a setpoint by 1 changes the height of the chromatogram by a factor of 2. The following chromatograms illustrate this. Use the smallest possible value to minimize integration error.

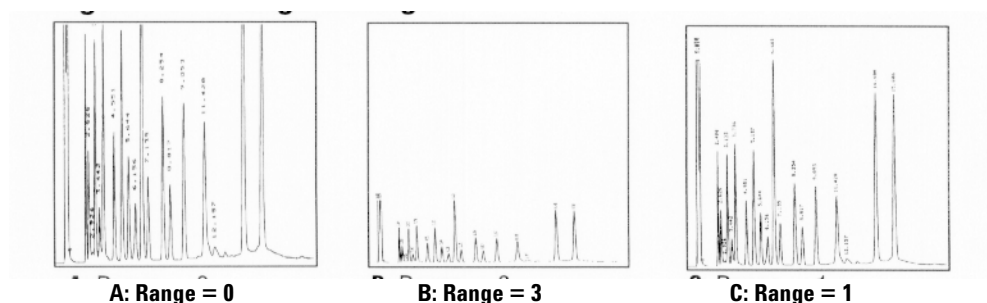

There are limits to usable range settings for some detectors. The table lists the valid range setpoints by detector.

Table 56 Range limits

Detector	Usable range settings (2 ^x)
FID	0 to 13
NPD	0 to 13
FPD	0 to 13
TCD	0 to 6
uECD	0 to 6
Analog input	0 to 7

Range may be run time programmed. See [“Run Time Programming”](#) on page 12 for details.

Analog data rates

Your integrator or recorder must be fast enough to process data coming from the GC. If it cannot keep up with the GC, the data may be damaged. This usually shows up as broadened peaks and loss of resolution.

Speed is measured in terms of bandwidth. Your recorder or integrator should have a bandwidth twice that of the signal you are measuring.

The GC allows you to operate at two speeds. The faster speed allows minimum peak widths of 0.004 minutes (8 Hz bandwidth), while the standard speed allows minimum peak widths of 0.01 minutes (1.6 Hz bandwidth).

If you use the *fast peaks* feature, your integrator should operate at around 15 Hz.

Selecting fast peaks (analog output)

- 1 Press **[Config][Analog 1]** or **[Config][Analog 2]**.
- 2 Scroll to **Fast peaks** and press **[On]**.

Agilent does not recommend using **Fast peaks** with a thermal conductivity detector. Since the gas streams switch at 5 Hz, the gain in peak width is offset by increased noise.

Digital Signals

The GC outputs digital signals only to an Agilent data system. The following discussions describe features that impact the data sent to data systems, not the analog data available to integrators. Access these features from the data system. These features are not accessible from the GC keypad.

Digital zero

Available only from an Agilent data system.

Digital signal outputs respond to a zero command by subtracting the signal level at the time of the command from all future values.

Signal Freeze and Resume

Available only from an Agilent data system.

Some run time operations, such as changing signal assignments or switching a valve, can cause baseline upsets. Other factors can cause baseline upsets also. The GC can compensate for this by pausing (freezing) the signal at a particular value, using that signal value for a specified duration, and then resuming normal signal output.

Consider a system that uses a switching valve. When the valve switches, an anomaly occurs in the baseline. By freezing and resuming the signal, the anomaly can be removed so that the peak identification and integration software operates more smoothly.

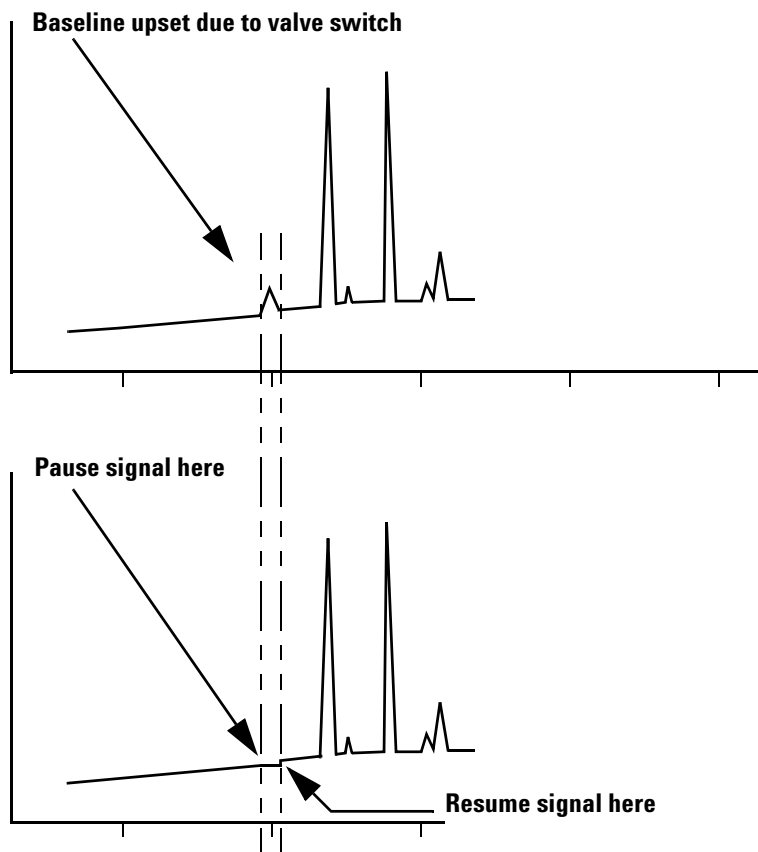

Data rates with Agilent data systems

The GC can process data at various data rates, each corresponding to a minimum peak width. The table shows the effect of data rate selection.

Table 57 Agilent data system data processing

Data rate, Hz	Minimum peak width, minutes	Relative noise	Detector	Column type
500	0.0001	5	FID	Narrow-bore, 0.05 mm
200	0.001	3.1	FID	Narrow-bore, 0.05 mm
100	0.002	2.2	FID/FPD/NPD only	Capillary
50	0.004	1.6		
20	0.01	1		

Table 57 Agilent data system data processing (continued)

Data rate, Hz	Minimum peak width, minutes	Relative noise	Detector	Column type
10	0.02	0.7		
5	0.04	0.5		to
2	0.1	0.3	All types	
1	0.2	0.22		
0.5	0.4	0.16		
0.2	1.0	0.10		
0.1	2.0	0.07		Slow packed

You cannot change the data rate during a run.

You will see higher relative noise at the faster sampling rates. Doubling the data rate can double peak height while the relative noise increases by 40%. Although noise increases, the signal-to-noise ratio is better at the faster rates.

This benefit only occurs if the original rate was too low, leading to peak broadening and reduced resolution. We suggest that rates be chosen so that the product of data rate and peak width in seconds is about 10 to 20.

The figure shows the relationship between relative noise and data rates. Noise decreases as the data rate decreases until you get to data rates of around 5 Hz. As the sampling rate slows, other factors such as thermal noise increase noise levels.

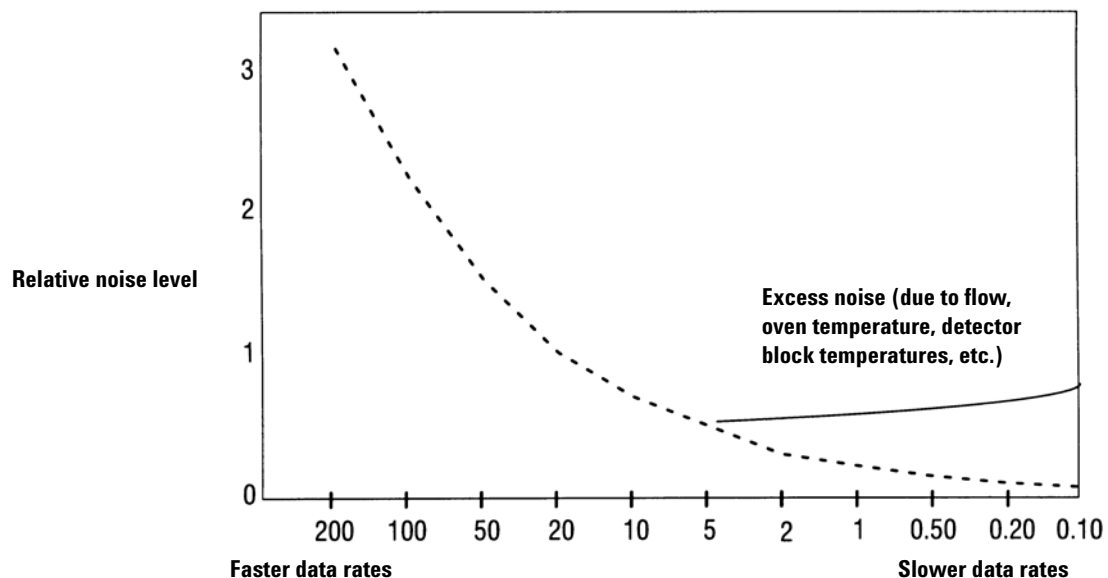

Zero Init Data Files

This feature applies to digital output only, and is mainly intended for non-Agilent data systems. It may help systems that have trouble with non-zero baseline output.

When you turn it **On**, the GC immediately begins to subtract the current detector output value(s) from any future values. For example, if you turn it on when the output is 20 pA, the GC subtracts 20 pA from the digital output until you turn Zero Init Data Files **Off**.

You will not see any change in the GC display, but you will see the change in the online plot available in the data system.

To change this setting, press **[Config]**, scroll to **Instrument**, then scroll to **Zero Init Data Files**.

Column Compensation

In temperature programmed analysis, bleed from the column increases as the oven temperature rises. This causes a rising baseline which makes peak detection and integration more difficult. Column compensation corrects for this baseline rise.

A column compensation run is made with no sample injected. The GC collects an array of data points from all 4 detectors, whether installed, off, or working. If a detector is not installed or is turned off, that part of the array is filled with zeros.

One array (Column compensation 1) can be created for analog signals. Two independent arrays (Column compensation 1 and 2) can be created for digital signals.

Each array defines a set of curves, one for each detector, that can be subtracted from the *real* run to produce a flat baseline. The next figure illustrates the concept.

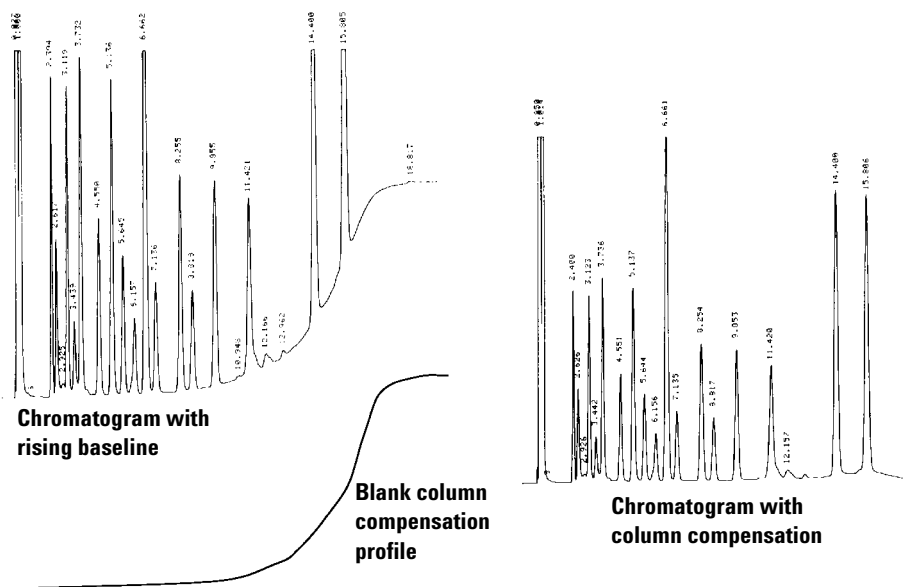

All conditions must be identical in the column compensation run and the *real* run. The same detector and column must be used, operating under the same temperature and gas flow conditions.

Creating a column compensation profile

- 1 Set up the instrument for a run.
- 2 Make a blank run to verify that the baseline is clean. This is particularly important for new conditions or if the GC has been idle for several hours.
- 3 Press [**Column Comp**].
- 4 Select **Col comp 1** or **Col comp 2** (these are the two arrays).
- 5 Select **Start compensation run** and press [**Enter**].
- 6 If the run is successful, the first line of the parameter list will say **Data ok**, and a time and date will appear at the bottom.

Making a run using analog output column compensation

- 1 Set the chromatographic conditions. They must be identical to those in the stored column compensation run except that **Final time** in the last ramp of the oven program can be longer or shorter.
- 2 Press [**Analog Out 1**] or [**Analog Out 2**].
- 3 Scroll to **Type** and press [**Mode/Type**].
- 4 The choices for an analog signal are:
 - Front detector
 - Back detector
 - Front - column comp 1
 - Front column compensation 1
 - Back column compensation 1
 - Aux 1 column compensation 1
 - Aux 2 column compensation 1
 - Test plot
- 5 Choose an option from the list.
- 6 Enter setpoints for **Zero** and **Range**, if applicable.
- 7 Start your run.

Making a run using digital output column compensation

- 1 Set each detector output separately.
- 2 Press [**Config**][**Detector name**]. Scroll to **Signal** and press [**Mode/Type**]. Select from:
 - No Column Compensation
 - Detector - ColComp 1
 - Detector - ColComp 2

This changes the digital output. You cannot get both compensated and uncompensated digital data from the same detector at the same time. However, it does not affect the analog output.

Plotting a stored column compensation profile

- 1 Press [**Analog Out 1**] or [**Analog Out 2**].
- 2 Scroll to **Type:** and press [**Mode/Type**].
- 3 Select the profile to be plotted.
- 4 Press [**Start**].

Test Plot

Test plot is an internally generated “chromatogram” that can be assigned to a signal output channel. It consists of three baseline-resolved, repeating peaks. The area of the largest is approximately 1 Volt-sec, the middle one is 0.1 times the largest, and the smallest is 0.01 times the largest.

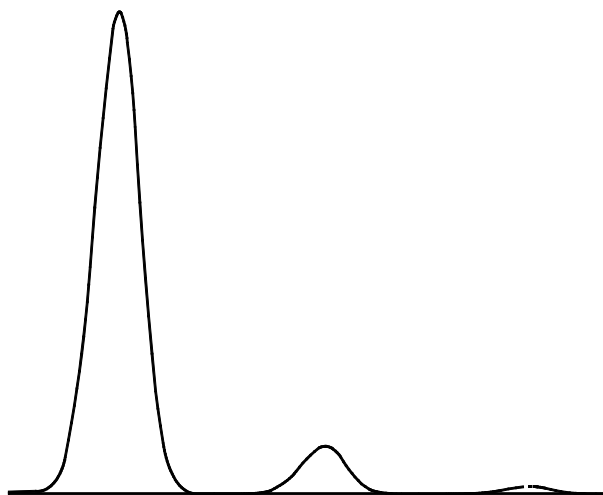

Test plot can be used to verify the operation of external data processing devices without having to perform repeated chromatographic runs. It may also be used as a stable signal to compare the results from different data processing devices.

To use the Test Plot:

- 1 Press **[Analog Out 1]** or **[Analog Out 2]**.
- 2 Scroll to **Type:** and press **[Mode/Type]**.
- 3 Choose **Test Plot**.
- 4 Press **[Start]**. The plot will repeat until you press **[Stop]**.

Test Plot is the default choice for the analog outputs.

7 GC Output Signals



8 Auxiliary Devices

Auxiliary Devices	244
About Auxiliary Pressure Control	244
About Aux Thermal Zone Control	245
About Cryo Trap Control	245
About Auxiliary Device Contacts	246
About the 24V Auxiliary Device Power Supply	246
About Auxiliary Columns	246
About Auxiliary Detectors	247

Auxiliary Devices

About Auxiliary Pressure Control

Pressure units

There are two common ways of expressing gas pressures:

psia Absolute pressure, measured relative to vacuum.

psig Gauge pressure, measured relative to atmospheric pressure. This name is used because most pressure gauges have one side of the sensing element exposed to the atmosphere.

The two measurements are related by:

$$psia = psig + atmospheric\ pressure$$

Two-channel pressure control module (PCM)

The PCM has two different channels. Channel 1 may be either flow or pressure controlled and may be flow/pressure programmed. It is essentially identical to the packed column inlet flow module (see [“About the Multimode Inlet”](#)).

Channel 2 is pressure only, but may be used in either a forward- or back-pressure mode by changing connections.

Both channels are controlled by the same parameter list. The first two lines are for channel 1; the remaining lines are for channel 2.

The forward-pressure mode requires the user to supply a downstream flow resistance, possibly a frit.

The back-pressure mode is most useful with gas sampling valves. By connecting the sample exit line from the valve to the vent fitting of the PCM, pressure in the sample loop can be controlled.

Three-channel auxiliary pressure controller (Aux PCM)

All channels are 3-ramp programmable. Up to three modules may be installed, for a total of 9 pressure-regulated channels.

Setting parameters for auxiliary pressure control

- 1 Press [**Aux EPC #**] and scroll to the channel you wish to control. Press [**Enter**].
- 2 Scroll to **Initial pressure**. Enter a value and press [**Enter**].
- 3 If desired, enter a pressure program using the **time** and **rate** functions.
- 4 Press [**On/Yes**] to apply **Initial pressure** and start the program.

About Aux Thermal Zone Control

There can be up to 3 aux thermal controlled zones.

These zones are 3-ramp programmable.

Run time events may be used to schedule specific temperatures during the run.

Setting parameters for the aux thermal zone control

- 1 Press [**Aux Temp #**] and scroll to the zone you wish to control. Press [**Enter**].
- 2 Scroll to **Temperature**. Enter a value and press [**Enter**].
- 3 Scroll to **Initial time**. Enter a value and press [**Enter**].
- 4 Scroll to **Rate 1**. Enter **0** to end the program here or a positive value to create a temperature program.

About Cryo Trap Control

When configured as a cryo trap, an aux thermal zone has the following parameters:

Temperature Displays the current trap temperature and setpoint. Press [**On/Off**] to turn the zone on or off.

- If **On**, the cryo trap temperature will remain 10 °C above the current oven temperature, following the oven program.
- If **Off**, the GC does not control the trap temperature.

Cold Trap Temperature Enter the target temperature for cryo trap operation and press [**Enter**]. Enable this temperature using run time **On** and **Off** events for the aux thermal zone.

To use the cryo trap during a run:

- 1 Press [**Aux Temp #**] and scroll to the zone you wish to control. Press [**Enter**].
- 2 Scroll to **Temperature**. Press [**On/Off**] to turn the zone on or off, as desired (typically, **On**).
- 3 Scroll to **Cold Trap Temperature**. Enter a value and press [**Enter**].
- 4 Press [**Run Table**].
- 5 Press [**Mode/Type**].
- 6 Scroll to **Cryo trap**. Press [**Enter**] to add a cryo trap event to the run table.
- 7 Enter a value for the **Time:** and press [**Enter**]. Scroll to **Cryo trap cooling** and press [**On/Yes**] to turn it on.

This event sets the cryo trap temperature to the **Cold Trap Temperature** setpoint. The trap remains at this temperature until another event turns it off, or until the run ends.

- 8 Enter another **Cryo Trap** event to turn the trap temperature **Off** at the desired run time.

This event sets the cryo trap to track the oven temperature + 10 °C for the remainder of the run.

About Auxiliary Device Contacts

These contacts are controlled by the external valve drivers. See “[The external valve drivers](#)” on page 220.

About the 24V Auxiliary Device Power Supply

This is controlled by the external valve drivers. See “[The external valve drivers](#)” on page 220.

About Auxiliary Columns

Defines up to 6 columns (includes **Col 1** and **Col 2**).

- 1 Press [**Config**][**Aux Col #**] and enter a column number. Press [**Enter**].
- 2 Define/configure the column.

About Auxiliary Detectors

The GC supports up to two auxiliary detectors in addition to the Front and Back detectors that mount on the top of the oven.

Aux Det # 1 This can only be a TCD, and mounts in a carrier on the left side of the oven together with its flow module.

Aux Det # 2 This can only be an analog input board (AIB). It is used to receive and process data from a non-Agilent detector or other source.

